



Product Catalog



Medical Solutions

I N T E R N A T I O N A L



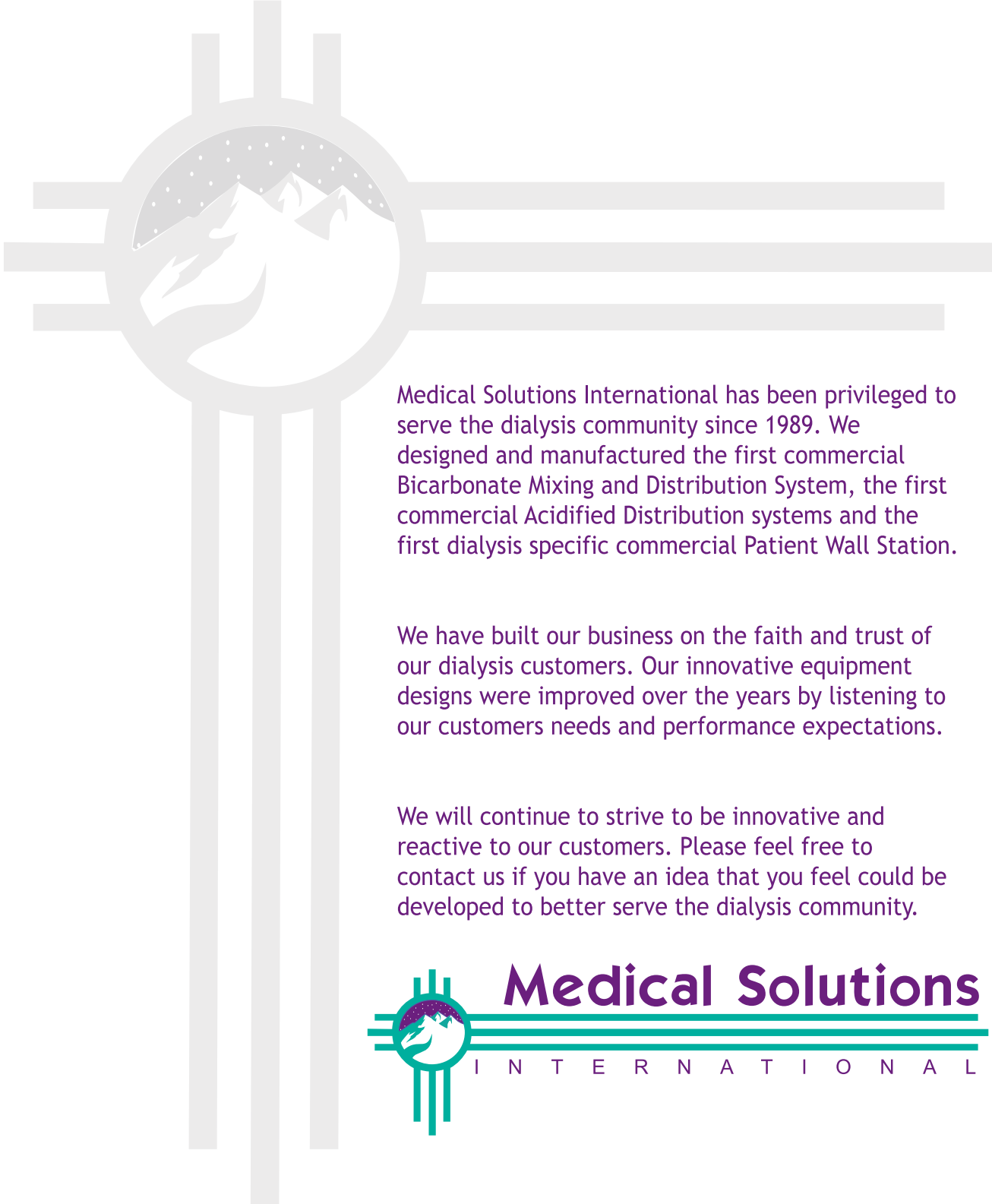

Medical Solutions International has been privileged to serve the dialysis community since 1989. We designed and manufactured the first commercial Bicarbonate Mixing and Distribution System, the first commercial Acidified Distribution systems and the first dialysis specific commercial Patient Wall Station.

We have built our business on the faith and trust of our dialysis customers. Our innovative equipment designs were improved over the years by listening to our customers needs and performance expectations.

We will continue to strive to be innovative and reactive to our customers. Please feel free to contact us if you have an idea that you feel could be developed to better serve the dialysis community.



TABLE OF CONTENTS

Call: 1-800-326-5275
 Available Monday thru
 Friday 8:00AM-4:00PM CST

OPTION 2

Email: sales@medicalsolutionskc.com
 Customer support available
 Monday thru Friday 8:00AM-4:00pm CST

OPTION 3

Fax: Fill out order form found in the
 back of catalog or feel free to send
 your own purchase order form.

OPTION 4

Mail: Send order form to our main office:

Medical Solutions International
 5646 Merriam Drive
 Merriam, KS 66203

Catalog also available on-line
www.medicalsolutionskc.com

SDS-CB200 DUAL TANK BICARB SYSTEM	1
CHLORINE TIMER AND REMOTE	2
CITRIC JUG TEE, BLEACH CAP & JUG TAP	3
ACIDIFIED DISTRIBUTION	4
MR. ACID	5
CRANK HOLDER/SAMPLE CENTER	6
OZONE ACCESSORIES	7
WALL TECH STATION	8-12
WALL TECH STATION ADAPTERS	13-16
CLEAR SCREEN PROTECTOR	17
BICARB SYSTEM ACCESSORIES	18-20
FUSES / SWITCHES / SENSORS	21
ELECTRICAL	22
PRESSURIZED PRODUCTS	23
CAMLOCKS / BANJO BULKHEAD	24
FILTERS	25
PUMPS	26-27
HOSE / CLAMPS / CLICS	28
TUBING	29
PVC SCHEDULE 80 FITTINGS	30-41
NIPPLES	42-44
BALL VALVES	45
CHECK VALVES / GATE VALVES	46
BARBED FITTINGS	47
QUICK DISCONNECT FITTINGS	48-59
PARKER FITTINGS	60-62
MUR-LOK	63-66
GARDEN HOSE FITTINGS	67
TANKS	68
ORDER FORM	69

Medical Solutions

INTERNATIONAL

Bicarbonate Mixing & Distribution System

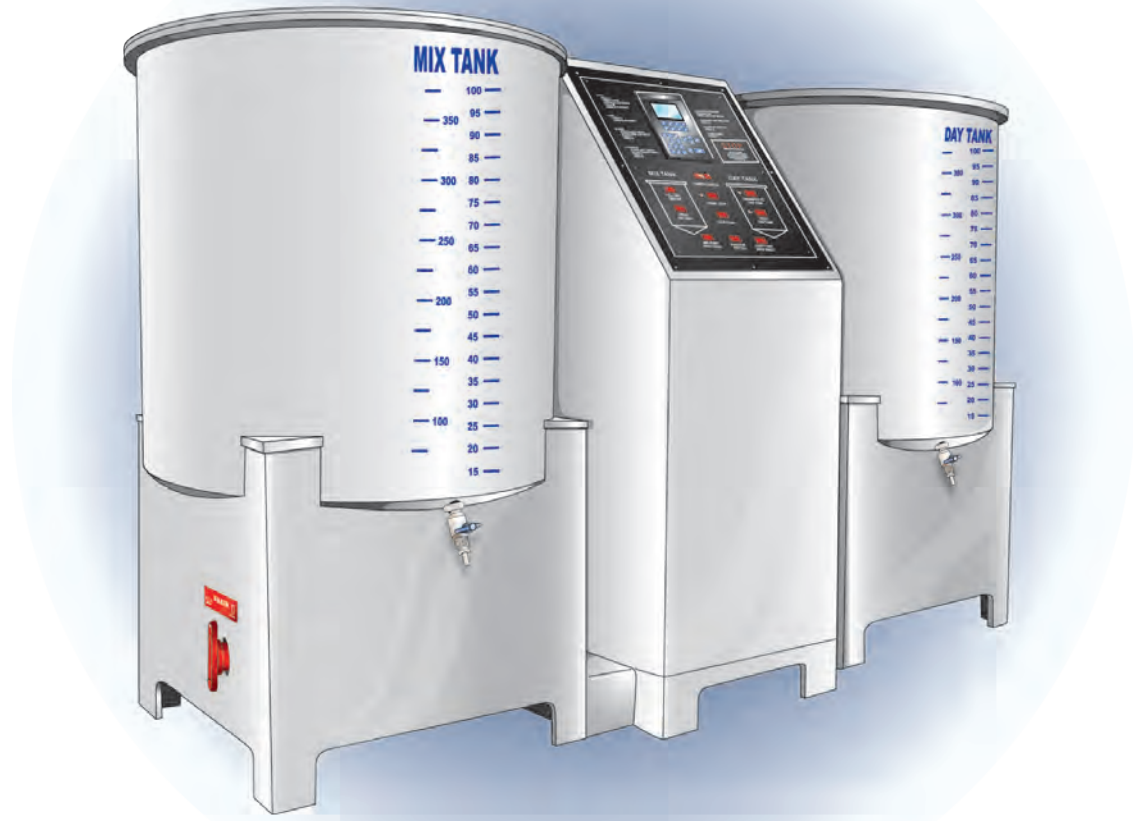

Dual Tank Bicarbonate Mixing and Pressurized Distribution System

These systems have 25 to 100 gallon mixing capacity, with electronic fill and dispense options, variable batch size, internally balanced agitation, sanitization/disinfection mode, a .2 micron air filter, and timed cycle processing, they employ two 100 gallon tanks, one for mixing and one for distribution. With this system, you may effectively reconstitute dialysate powders in a closed system with a managed fill to accomplish predictable/reproducible batch quality.

The systems are designed for low volume, low pressure dynamic distribution of mixed Bicarb concentrate to patient stations. The systems lend themselves to simple, complete sanitization and effective rapid rinse. The system is

SDS-CB200 DUAL TANK BICARBONATE MIXING & DISTRIBUTION 1

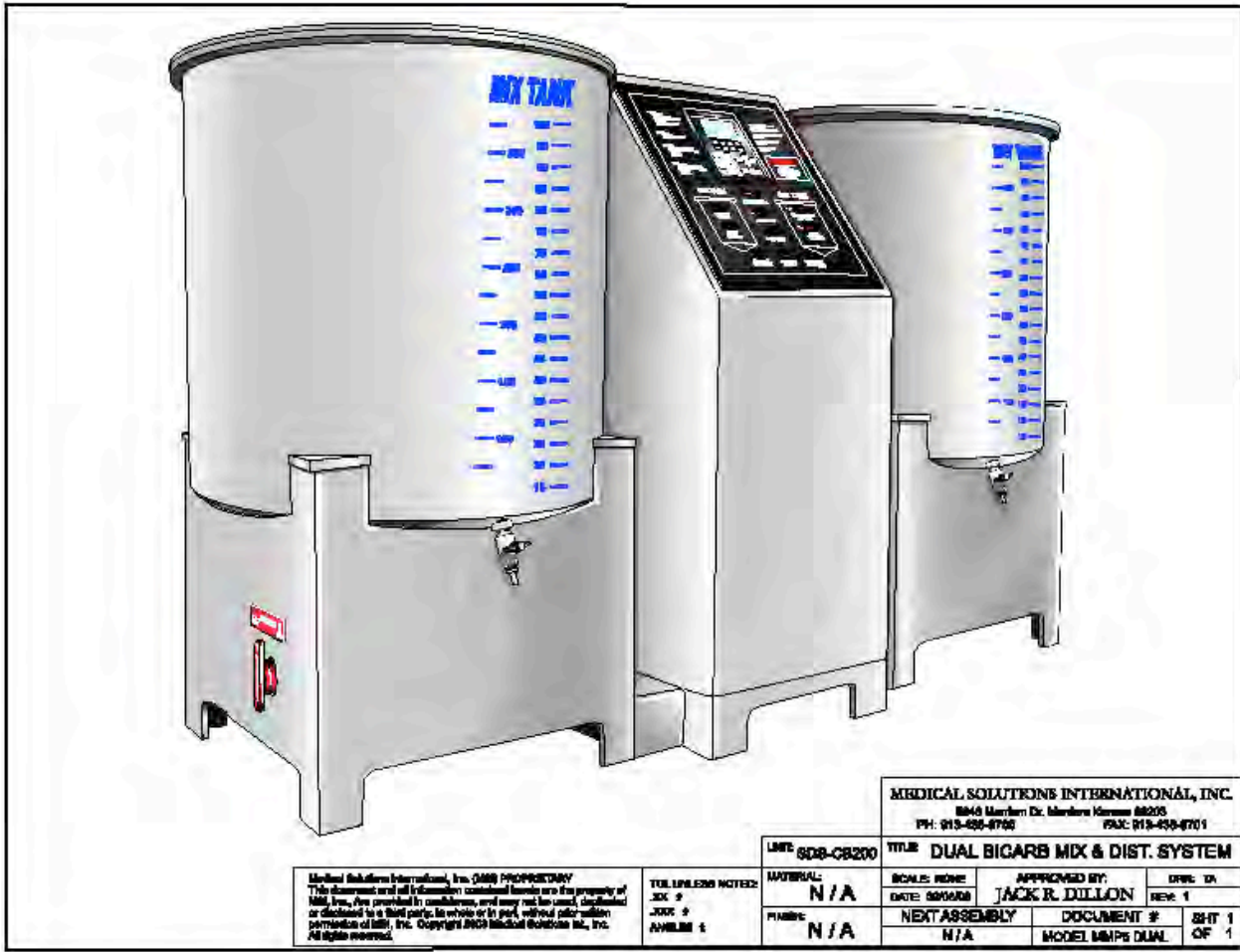

MEDICAL SOLUTIONS INTERNATIONAL, INC.
 8848 Merriam Dr. Merriam, Kansas 66205
 PH: 913-438-9700 FAX: 913-438-9701

UNIT: SDS-CB200	TITLE: DUAL BICARB MIX & DIST. SYSTEM
MATERIAL: N/A	SCALE: NONE
DATE: 05/20/00	APPROVED BY: JACK R. DILLON
FINISH: N/A	DATE: 05/20/00
	REVISION: 1
	MODEL: MMS DUAL
	REV: 1
	OF 1

Medical Solutions International, Inc. (MSI) PROPRIETARY
 This document and all information contained herein are the property of
 MSI. Use, copy, or disclosure in any form, without prior written
 permission of MSI, Inc. Copyright 2000 Medical Solutions Int., Inc.
 All rights reserved.

TITLE/UNLESS NOTED:
 JOB #
 ANGLE #

CALL FOR BICARBONATE SYSTEMS QUOTATIONS

ELECTRICAL CONTROL BOXES		
PART NUMBER	PRODUCT DESCRIPTION	PRICE \$
M-MXR-LTA	Low Tank Alarm	495.25
M-RA02	Bicarb Remote Alarm with Reset Mute	641.25



MEDICAL SOLUTIONS INTERNATIONAL
 5646 MERRIAM DRIVE
 MERRIAM, KS 66203
www.medicalsolutionskc.com

800.326.5275
 913.438.9700
 FAX 913.438.9701

"It won't let you forget".

Chlorine test timer

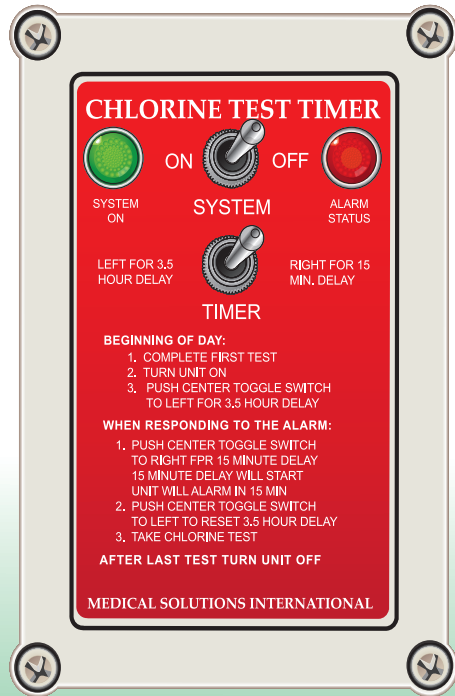

M-CT02

Remote Alarm

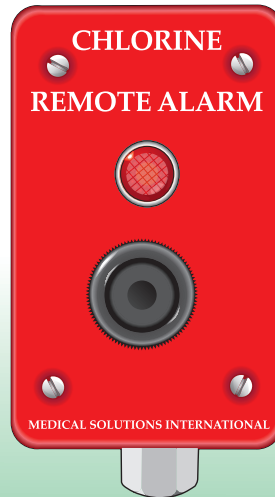

M-RA03



medicalsolutionskc.com 800-326-5275

CHLORINE TIMER AND REMOTE

PART NUMBER	PRODUCT DESCRIPTION	PRICE \$
M-CT02	Chlorine Timer	608.33
M-RA03	Remote Alarm for Chlorine Timer	129.95

MEDICAL SOLUTIONS INTERNATIONAL
 5646 MERRIAM DRIVE
 MERRIAM, KS 66203
www.medicalsolutionskc.com

800.326.5275
 913.438.9700
 FAX 913.438.9701

Red Jug Tap

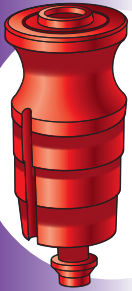

M-JT-R

Blue Jug Tap



M-JT-B



"Clean, Neat, No Mess".



CAT-3
Citric Acid
Jug Tee

CAT-2
Vinegar
Jug Tee



Bleach Cap

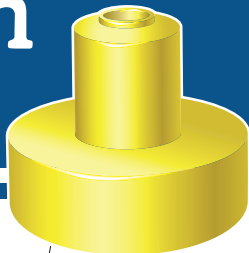

Cap Only
(Jar not included)

Part No#
K-FRE-BC
"ALL PLASTIC"



JUG TAP, TEES & CAPS

PART NUMBER	PRODUCT DESCRIPTION	PRICE \$
CAT-3	Citric Acid Jug Tee	49.20
CAT-2	Vinegar Jug Tee	49.20
K-FRE-BC	Bleach Cap	26.60
M-JT-R	Red Acid Jug Tap	16.13
M-JT-B	Blue Bicarb Jug Tap	16.13

MEDICAL SOLUTIONS INTERNATIONAL
5646 MERRIAM DRIVE
MERRIAM, KS 66203
www.medicalsolutionskc.com

800.326.5275
913.438.9700
FAX 913.438.9701

MEDICAL SOLUTIONS INTERNATIONAL



ACIDIFIED CONCENTRATE DISTRIBUTION SYSTEM

We use all corrosion resistant materials as well as FDA registered process piping, tanks, controls, etc. The system is designed to transfer acidified concentrate from bulk storage to the patient stations by controlled low pressure pump. The system consists of transfer pumps, valves, fittings, and a complete electronic control. Includes pressurized jug fill.

ACIDIFIED SYSTEMS WITH TANKS

PART NUMBER	PRODUCT DESCRIPTION	PRICE \$
APDS-CAB3	Acidified Distribution Cabinet	2954.00
T-10250-R	250 Gallon Conical with Red Base	QUOTE
T-10250-Y	250 Gallon Conical with Yellow Base	QUOTE

MEDICAL SOLUTIONS INTERNATIONAL
 5646 MERRIAM DRIVE
 MERRIAM, KS 66203
www.medicalsolutionskc.com

800.326.5275
 913.438.9700
 FAX 913.438.9701

MR. ACID-ACIDIFIED JUG FILLING

5



Mr. Acid! is clean, spill free and easy. No more slick dangerous floors. No more spilling and sliding. No more ruined shoes and floors.

This patented system is made to fit right on the acid drum or can be ordered for carts to fill from bulk storage tanks.

This Is Just Too Easy! Automatic Jug Filling!

Just place the jug, push the button, walk away ... Mr. Acid! will fill the jug and automatically shut off when full. Mr. Acid! works on any dialysis machine jug and works with any acidified concentration or with bicarb.

MR. ACID		
PART NUMBER	PRODUCT DESCRIPTION	PRICE \$
M-ADU-55	Mr. Acid	1318.45
M-A-DW01	Mr. Acid Drum Wand	21.53



MEDICAL SOLUTIONS INTERNATIONAL
5646 MERRIAM DRIVE
MERRIAM, KS 66203
www.medicalsolutionskc.com

800.326.5275
913.438.9700
FAX 913.438.9701

SAMPLE — — CENTER

- EASY
- SIMPLE
- CONVENIENT
- CLEAN

STORE YOUR TESTING EQUIPMENT
CONVENIENTLY AWAY...



Medical Solutions
INTERNATIONAL
www.medicalsolutionskc.com
800-326-5275

"Don't be caught with out your crank".

Machine Crank Holder
M-FCH-001



medicalsolutionskc.com 800-326-5275

SAMPLE STATION

PART NUMBER	PRODUCT DESCRIPTION	PRICE \$
M-FCH-001	Machine Crank Holder	11.94
SS-101	Pre-Treatment Sample Station w/out Gauges	533.25
SS-101-PG	Pre-Treatment Sample Station w/ Gauges	845.25

MEDICAL SOLUTIONS INTERNATIONAL
5646 MERRIAM DRIVE
MERRIAM, KS 66203
www.medicalsolutionskc.com

800.326.5275
913.438.9700
FAX 913.438.9701



Z-C30ZX

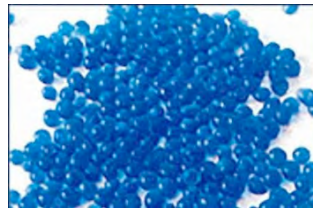

O3-DRF-8



BEFORE AFTER



O3-T

PART NUMBER	PRODUCT DESCRIPTION	PRICE \$
O3-DRF-H1	Ozone Dessicant Filter Housing	39.95
O3-DRF-8	Ozone Air Drying Dessicant Refill	11.91
Z-C-30ZX	Ozone Ambient Air Monitor	695.75
Z-CX01	Exchange Cell for Ozone Unit	269.98
O3-T	Test Strips for Ozone (1 Bottle)	29.95
CV-14000	1/4" Check Valve	18.83

MEDICAL SOLUTIONS INTERNATIONAL
 5646 MERRIAM DRIVE
 MERRIAM, KS 66203
www.medicalsolutionskc.com

800.326.5275
 913.438.9700
 FAX 913.438.9701

Medical Solutions International



Wall Station for Dialysis

Our recessed dialysis wall stations include a solutions distribution center and drain. Each is 18" wide by 18" high, and made of high quality molded polyethylene. The durable material can be fitted with a variety of valves, fittings, pressure gauges and quick connects so as to accommodate the installation of compatible dispensing with any dialysis delivery system on the market today. The easily cleaned, chemical resistant wall station also receives the drainage from the dialysis machine. The drip-proof cantilever valve block keeps the unit free of spills and stains. All valving is color coded and signage designated.

CALL FOR QUOTATION OF THE CONFIGURATION THAT
WORKS BEST FOR YOU FACILITY!

MEDICAL SOLUTIONS INTERNATIONAL
5646 MERRIAM DRIVE
MERRIAM, KS 66203
www.medicalsolutionskc.com

800.326.5275
913.438.9700
FAX 913.438.9701

AIR GAP DRAIN ASSEMBLY DIAGRAM PG.16

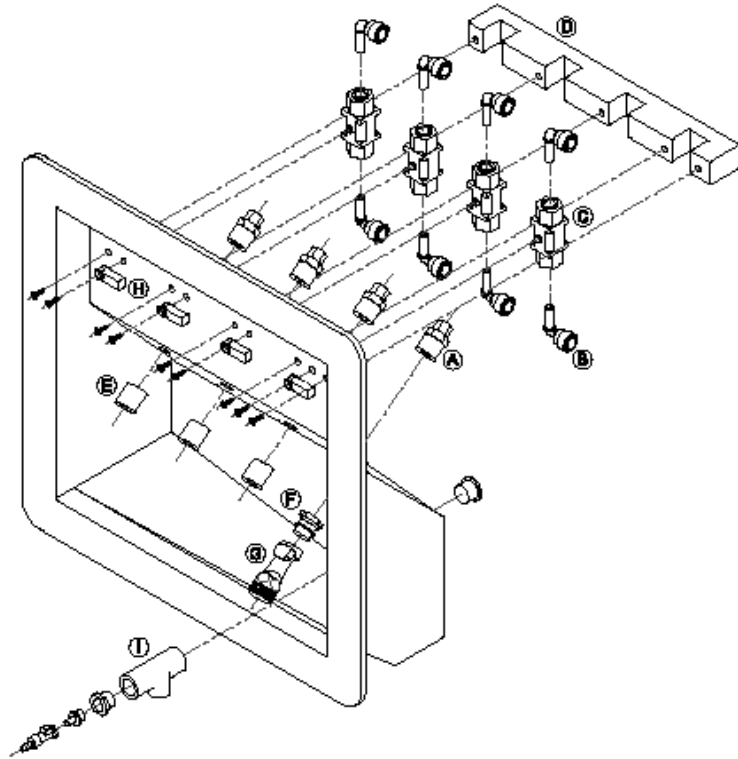

NOTE:
TURNED (NOT 28-ROW) PLUMB FROM
ON TO DR. TYPICAL 4 PLACES.

- A. P6FC8
- B. ML-T0620666
- C. ML-G0620625
- D. W-M11X4 (4 SLOT MANIFOLD)
- E. W-FRE-850 (RED, BLUE, YELLOW, WHITE)
- F. QD-HFCD24812
- G. QD-HFCD101235GHT
- H. HM001(BLUE, RED, GREEN, ORANGE, YELLOW)
- I. W-CNC-AGD (AIR GAP DRAIN ASSEMBLY)

MEDICAL SOLUTIONS INTERNATIONAL
5646 MERRIAM DRIVE
MERRIAM, KS 66203
www.medicalsolutionskc.com

800.326.5275
913.438.9700
FAX 913.438.9701

BEIGE WALL STATIONS

PART NUMBER	PRODUCT DESCRIPTION	PRICE \$
W-RPWS-B000	Beige Wallstation Blank	214.65
W-RPWS-B022	Beige Wallstation with 2 Bicarb and 2 Acid	321.35
W-RPWS-B100	Beige Wallstation with 1 Water	282.08
W-RPWS-B101	Beige Wallstation with 1 Water and 1 Acid	336.96
W-RPWS-B102	Beige Wallstation with 1 Water and 2 Acid	389.14
W-RPWS-B103	Beige Wallstation with 1 Water and 3 Acid	443.88
W-RPWS-B104	Beige Wallstation with 1 Water and 4 Acid	497.81
W-RPWS-B105	Beige Wallstation with 1 Water and 5 Acid	551.74
W-RPWS-B110	Beige Wallstation with 1 Water and 1 Bicarb	336.96
W-RPWS-B111	Beige Wallstation with 1 Water, 1 Bicarb and 1 Acid	389.95
W-RPWS-B112	Beige Wallstation with 1 Water, 1 Bicarb and 2 Acid	443.88
W-RPWS-B113	Beige Wallstation with 1 Water, 1 Bicarb and 3 Acid	497.81
W-RPWS-B114	Beige Wallstation with 1 Water, 1 Bicarb and 4 Acid	551.75
W-RPWS-B200	Beige Wallstation with 2 Water	350.86
W-RPWS-B222	Beige Wallstation with 2 Water, 2 Bicarb and 2 Acid	565.25
W-RPWS-B300	Beige Wallstation with 3 Water	416.95

REFER TO PAGE 9

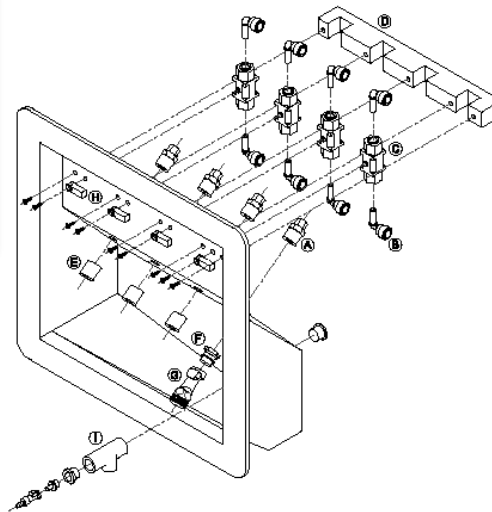

MEDICAL SOLUTIONS INTERNATIONAL
 5646 MERRIAM DRIVE
 MERRIAM, KS 66203
www.medicalsolutionskc.com

800.326.5275
 913.438.9700
 FAX 913.438.9701

GRAY WALL STATIONS

PART NUMBER	PRODUCT DESCRIPTION	PRICE \$
W-RPWS-G000	Gray Wallstation Blank	214.65
W-RPWS-G013	Gray Wallstation with 1 Bicarb and 3 Acid	496.53
W-RPWS-G100	Gray Wallstation with 1 Water	282.08
W-RPWS-G101	Gray Wallstation with 1 Water and 1 Acid	336.96
W-RPWS-G102	Gray Wallstation with 1 Water and 2 Acid	389.95
W-RPWS-G103	Gray Wallstation with 1 Water and 3 Acid	443.88
W-RPWS-G104	Gray Wallstation with 1 Water and 4 Acid	497.81
W-RPWS-G105	Gray Wallstation with 1 Water and 5 Acid	551.74
W-RPWS-G110	Gray Wallstation with 1 Water and 1 Bicarb	336.96
W-RPWS-G111	Gray Wallstation with 1 Water, 1 Bicarb and 1 Acid	389.95
W-RPWS-G112	Gray Wallstation with 1 Water, 1 Bicarb and 2 Acid	443.88
W-RPWS-G113	Gray Wallstation with 1 Water, 1 Bicarb and 3 Acid	497.81
W-RPWS-G114	Gray Wallstation with 1 Water, 1 Bicarb and 4 Acid	551.75
W-RPWS-G200	Gray Wallstation with 2 Water	350.86
W-RPWS-G202	Gray Wallstation with 2 Water and 2 Acid	457.38
W-RPWS-G222	Gray Wallstation with 2 Water, 2 Bicarb and 2 Acid	565.24

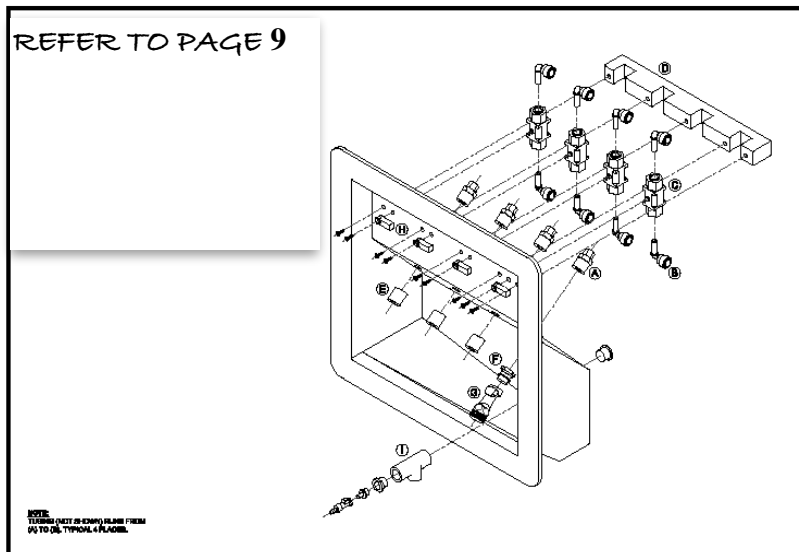

MEDICAL SOLUTIONS INTERNATIONAL
 5646 MERRIAM DRIVE
 MERRIAM, KS 66203
www.medicalsolutionskc.com

800.326.5275
 913.438.9700
 FAX 913.438.9701

WALL TECH STATIONS-WHITE

12

WHITE WALL STATIONS

PART NUMBER	PRODUCT DESCRIPTION	PRICE \$
W-RPWS-W000	White Wallstation Blank	214.65
W-RPWS-W100	White Wallstation with 1 Water	282.95
W-RPWS-W101	White Wallstation with 1 Water and 1 Acid	336.96
W-RPWS-W102	White Wallstation with 1 Water and 2 Acid	389.95
W-RPWS-W103	White Wallstation with 1 Water and 3 Acid	443.88
W-RPWS-W104	White Wallstation with 1 Water and 4 Acid	497.81
W-RPWS-W105	White Wallstation with 1 Water and 5 Acid	551.74
W-RPWS-W110	White Wallstation with 1 Water, 1 Bicarb	336.96
W-RPWS-W111	White Wallstation with 1 Water, 1 Bicarb and 1 Acid	389.95
W-RPWS-W112	White Wallstation with 1 Water, 1 Bicarb and 2 Acid	443.88
W-RPWS-W113	White Wallstation with 1 Water, 1 Bicarb and 3 Acid	497.81
W-RPWS-W114	White Wallstation with 1 Water, 1 Bicarb and 4 Acid	551.75
W-RPWS-W200	White Wallstation with 2 Water	349.52
W-RPWS-W202	White Wallstation with 2 Water and 2 Acid	457.38
W-RPWS-W222	White Wallstation with 2 Water, 2 Bicarb and 2 Acid	565.24

SMALL WHITE WALL STATIONS

PART NUMBER	PRODUCT DESCRIPTION	PRICE \$
W-RPWS-SW000	Small White Wallstation Blank	214.65
W-RPWS-SW003	Small White Wallstation with 3 Acid	376.45
W-RPWS-SW013	Small White Wallstation with 1 Bicarb and 3 Acid	376.45
W-RPWS-SW100	Small White Wallstation with 1 Water	282.08
W-RPWS-SW102	Small White Wallstation with 1 Water and 2 Acid	389.95
W-RPWS-SW110	Small White Wallstation with 1 Water and 1 Bicarb	336.96
W-RPWS-SW111	Small White Wallstation with 1 Water, 1 Bicarb and 1 Acid	389.95
W-RPWS-SW112	Small White Wallstation with 1 Water, 1 Bicarb and 2 Acid	443.88
W-RPWS-SW113	Small White Wallstation with 1 Water, 1 Bicarb and 3 Acid	497.81
W-RPWS-SW200	Small White Wallstation with 2 Water	348.97

MEDICAL SOLUTIONS INTERNATIONAL
5646 MERRIAM DRIVE
MERRIAM, KS 66203
www.medicalsolutionskc.com

800.326.5275
913.438.9700
FAX 913.438.9701



PHOENIX RINSE PORT



FRESENIUS REDUCER BUSHING
SHOWN IN CENTER

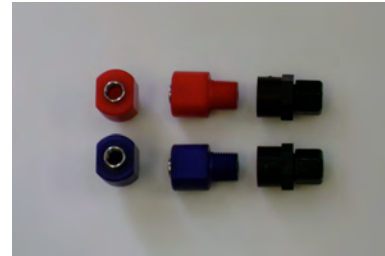

CHECKLESS FRESENIUS
RINSE PORT

IF YOU ARE STUCK WITH AN OLD DISTRIBUTION SYSTEM WITH 1/2" OF LARGER VALVES, HAVE WE GOT A SOLUTION FOR YOU! WE MANUFACTURE THESE SPECIAL ADAPTERS FOR FRESENIUS END POINT CONNECTORS. NOW YOU CAN UTILIZE OUR COILY'S AND CONNECT RIGHT FROM THE DIALYSIS DELIVERY MACHINE TO THE CONCENTRATE BALL VALVE WITHOUT MESSY INTERCONNECTS.

ADAPTERS		
PART NUMBER	PRODUCT DESCRIPTION	PRICE \$
W-FRE-R-850	Red 1/2" Male NPT X Fresenius Reducer Bushing	16.13
W-FRE-B-850	Blue 1/2" Male NPT X Fresenius Reducer Bushing	16.13
W-FRE-W-850	White 1/2" Male NPT X Fresenius Reducer Bushing	16.13
W-FRE-NC-R	Red Checkless Male NPT X Fresenius Reducer Bushing	29.95
W-FRE-NC-B	Blue Checkless Male NPT X Fresenius Reducer Bushing	29.95
W-PHX-RP-R	Red Phoenix Rinse Port	29.95
W-PHX-RP-B	Blue Phoenix Rinse Port	29.95
W-PHX-RP-W	White Phoenix Rinse Port	29.95
W-FRE-RS	Rubber Seal for Fresenius Rinse Port	0.34
W-RPWS-SCR/CAP-W	White Screw Cap Cover w/ Screw	1.65

MEDICAL SOLUTIONS INTERNATIONAL
5646 MERRIAM DRIVE
MERRIAM, KS 66203
www.medicalsolutionskc.com

800.326.5275
913.438.9700
FAX 913.438.9701

WALL TECH STATION ADAPTERS

14

ITEMS FOR ADAPTING FRESENIUS FITTINGS

PART NUMBER	PRODUCT DESCRIPTION	PRICE \$
W-FRE-W5-B	Fresenius Assembly Washer Blue	0.34
W-FRE-W5-R	Fresenius Assembly Washer Red	0.34
W-FRE-W5-W	Fresenius Assembly Washer White	0.34
W-FRE-W5-Y	Fresenius Assembly Washer Yellow	0.34
W-FRE-W.50	Bushing Spacer White	0.34



WALL STATION VALVE HANDLES

PART NUMBER	PRODUCT DESCRIPTION	PRICE \$
HB001	Blue Handle SMC	1.69
HR001	Red Handle SMC	1.69
HC001	Clear Handle SMC	1.69
HG001	Gray Handle SMC	1.69
HBL001	Black Handle SMC	1.69
HMB001	Blue Handle Murlock	1.69
HMR001	Red Handle Murlock	1.69
HMO001	Orange Handle Murlock	1.69
HMY001	Yellow Handle Murlock	1.69
HGR001	Green Handle Murlock	1.69



HANDLES IN MURDOCK GREEN



WALL STATION NYLON DRAIN BARBS

PART NUMBER	PRODUCT DESCRIPTION	PRICE \$
W-ATE2	Wallstation Drain 1" MNPT X 3/4" Barb Elbow	2.74
W-ATA1	Wallstation Drain 1" MNPT X 3/4" Barb Straight	2.74
436-113	Wallstation Drain 1" MNPT X 1-1/2" Socket Schedule 40	4.95

MEDICAL SOLUTIONS INTERNATIONAL
 5646 MERRIAM DRIVE
 MERRIAM, KS 66203
www.medicalsolutionskc.com

800.326.5275
 913.438.9700
 FAX 913.438.9701

WALL TECH STATION ITEMS

15

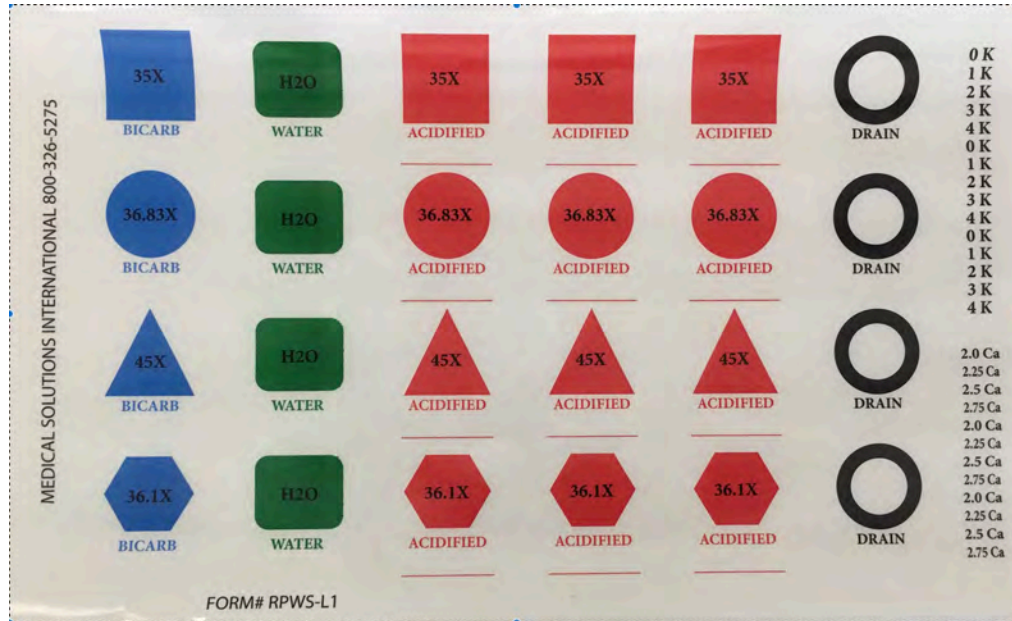

WALL STATION ITEMS

PART NUMBER	PRODUCT DESCRIPTION	PRICE \$
W-RPWS-L1	Labels for Recessed Patient Wallstation	1.65
P6FC8	3/8" Tube Compression X 1/2" Male NPT	6.92
P-OR.6	"O"RING for P6FC8 3/8" Tube Compression	0.34
QD-HFCD101235GHT	3/4" MGHT PSF Inline coupling insert w/Shut-off	22.52
QD-HFCD24812	1/2" MNPT PP Inline coupling insert w/Shut-off	15.78
W-ORING	"O" RING for Water Male QD-HFCD24812	0.37
W-ATE2	Wallstation Drain 1" MNPT X 3/4" Barb Elbow	2.74
W-ATA1	Wallstation Drain 1" MNPT X 3/4" Barb Straight	2.74
436-133	Wallstation Drain 1" MNPT x 1 1/2" Socket Schedule 40	4.95
W-M11X1	1 Slot Manifold for Wallstation	10.98
W-M11X2	2 Slot Manifold for Wallstation	12.96
W-M11X3	3 Slot Manifold for Wallstation	15.76
W-M11X4	4 Slot Manifold for Wallstation	26.81
W-M11X6	6 Slot Manifold for Wallstation	28.79

MEDICAL SOLUTIONS INTERNATIONAL
 5646 MERRIAM DRIVE
 MERRIAM, KS 66203
www.medicalsolutionskc.com

800.326.5275
 913.438.9700
 FAX 913.438.9701

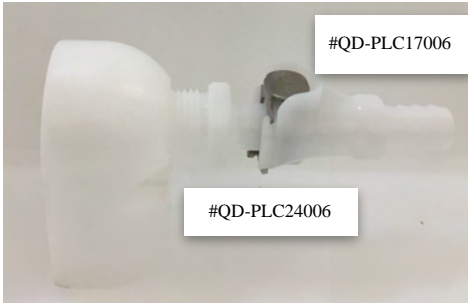

W-CNC-AGD- AIR GAP DRAIN ASSEMBLY



W-CNC-CAS

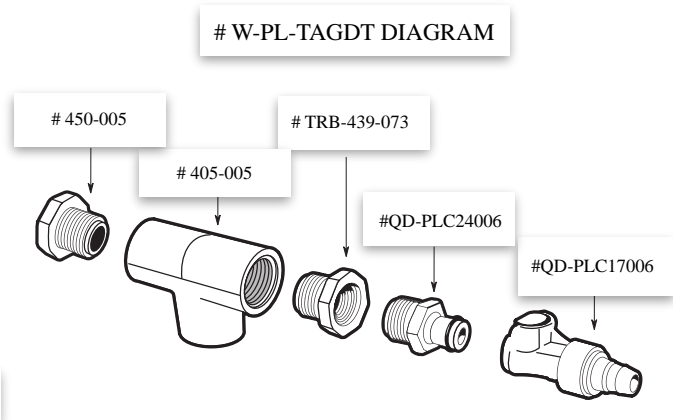

AIR GAP DRAIN ASSEMBLY

PART NUMBER	PRODUCT DESCRIPTION	PRICE \$
W-CNC-AGD	Air Gap Drain Assembly	29.95
W-CNC-CAS	Air Gap Body	19.98
W-PL-TAGD	Tee Style Sch 40 Air Gap Drain Assembly	29.95
W-PL-TAGDT	Threaded Tee Style Sch 40 Air Gap Drain Assembly	29.95

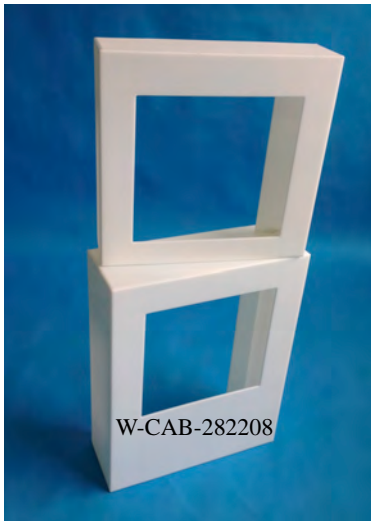

W-CAB-282208



WALL STATION CABINET

PART NUMBER	PRODUCT DESCRIPTION	PRICE \$
W-CAB-282208	Custom Wall Mounting Chase for RPWS (White)	495.25

MEDICAL SOLUTIONS INTERNATIONAL
 5646 MERRIAM DRIVE
 MERRIAM, KS 66203
www.medicalsolutionskc.com

800.326.5275
 913.438.9700
 FAX 913.438.9701

CLEAR SCREEN Protection

Protect your new monitor.... Refurbish your old....

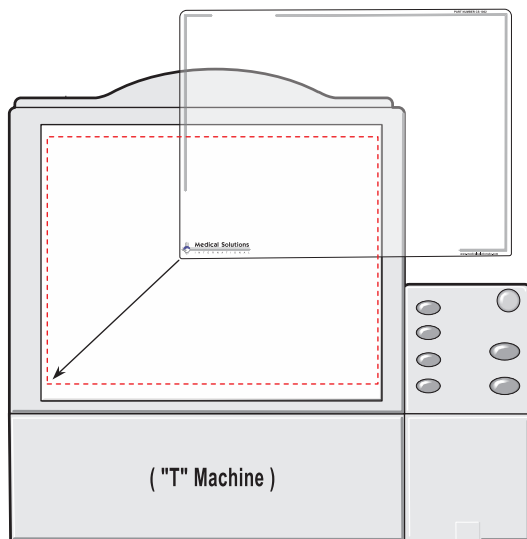

Clear Screen for T Machine

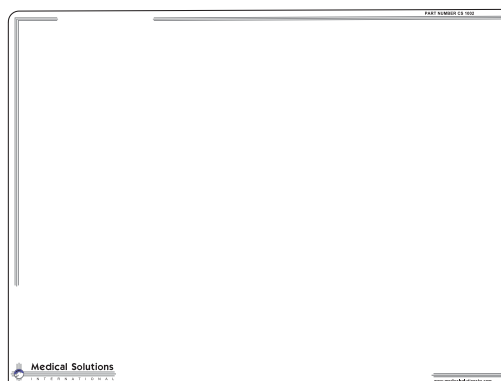

CS1002

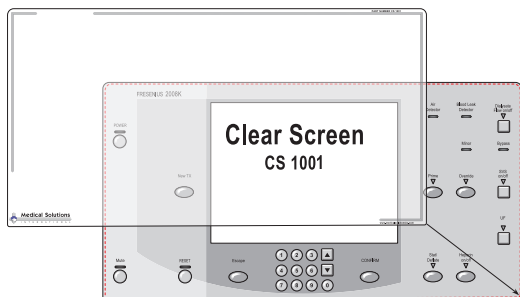

Fresenius 2008K

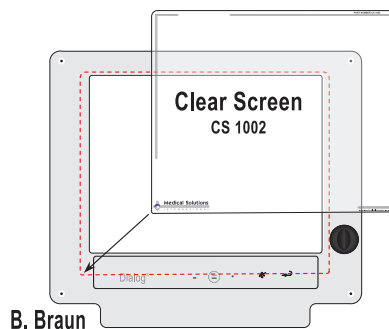

B. Braun

"Save your "T" screen".

"Stops cloudy screens".



medicalsolutionskc.com 800-326-5275

MEDICAL SOLUTIONS INTERNATIONAL
5646 MERRIAM DRIVE
MERRIAM, KS 66203
www.medicalsolutionskc.com

800.326.5275
913.438.9700
FAX 913.438.9701

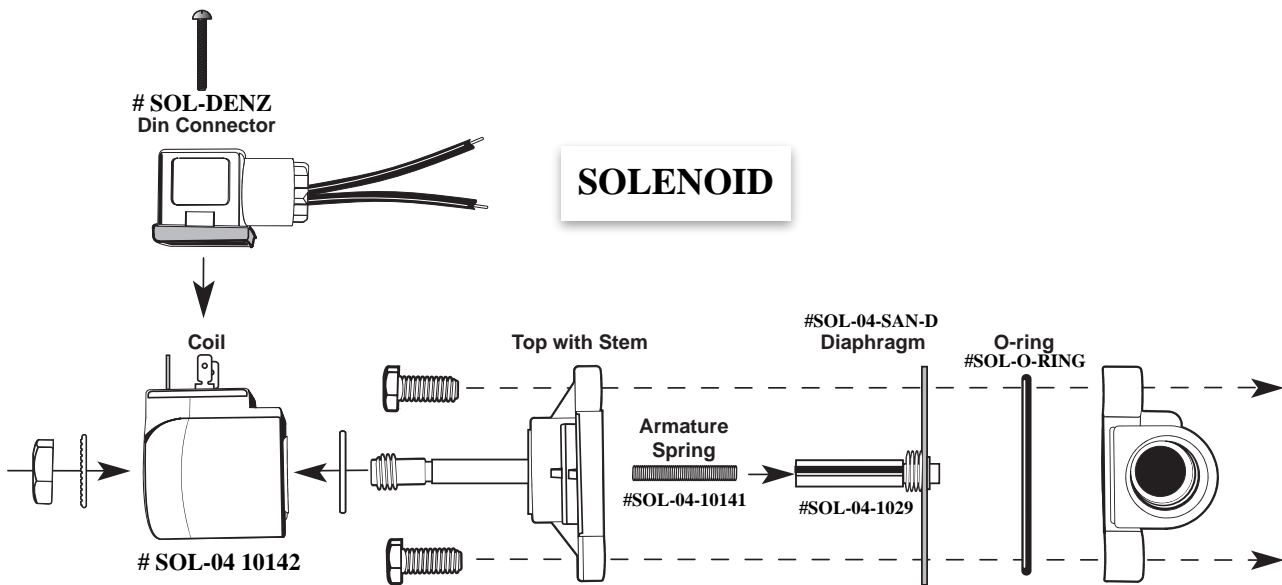

NOTE COLLAR

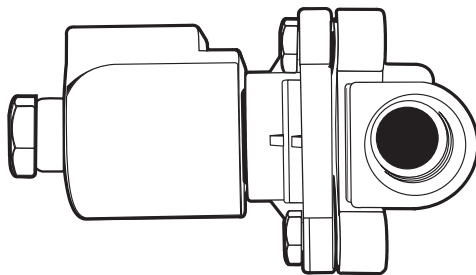

SOLENOID
Normally Open

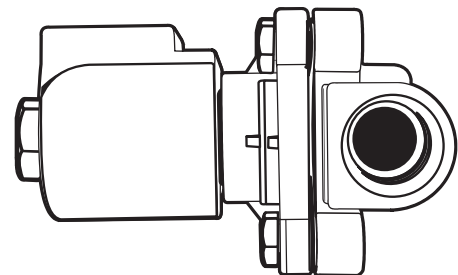

SOLENOID
Normally Closed

BICARB SYSTEM ACCESSORIES

19

SOLENOIDS

PART NUMBER	PRODUCT DESCRIPTION	PRICE \$
SOL-7524VNC	Solenoid 3/4" 24 VT NORMALLY CLOSED	120.98
SOL-7524VNO	Solenoid 3/4" 24 VT NORMALLY OPEN	193.58
SOL-04-10142	Coil for Zero Differential	17.85
SOL-04-SAN-D	Santilite Diaphragm	19.95
SOL-04-10141	Spring for SS Armature (PLUNGER)	5.62
SOL-04-10296V	SS Amature (PLUNGER)	12.97
SOL-DENZ	Solenoid Den Connector	3.71
SOL-O-RING	"O"RINGS for all Solenoids	5.83

NOTE COLLAR FOR
NORMALLY OPEN



INJECTORS

PART NUMBER	PRODUCT DESCRIPTION	PRICE \$
INJ-484	1/2" Injector Venturi-Kynar	121.43



EDUCTORS

PART NUMBER	PRODUCT DESCRIPTION	PRICE \$
ED-4927OPP	Eductor	53.86



SPRAY NOZZLES

PART NUMBER	PRODUCT DESCRIPTION	PRICE \$
SN-17020	1/4" Spiral Jet Spray Nozzle	25.81



MEDICAL SOLUTIONS INTERNATIONAL
5646 MERRIAM DRIVE
MERRIAM, KS 66203
www.medicalsolutionskc.com

800.326.5275
913.438.9700
FAX 913.438.9701

BICARB SYSTEM ACCESSORIES

20

HATCH COVER

PART NUMBER	PRODUCT DESCRIPTION	PRICE \$
HHC-711	Hinged Hatch Cover-Cam Latch	105.64
HHC-912	Hinged Hatch Cover-Pull Latch (Old Style)	105.64
HHC-316	Hinged Gasket Cord Kit	13.33
HHC-RETRO KIT	Kit Switching from HHC-912 to HHC-711	46.95



TANK LABELS

PART NUMBER	PRODUCT DESCRIPTION	PRICE \$
LDT-100	Day Tank Label	11.81
LMT-100	Mix Tank Label	11.81
LDT-50	Day Tank Label	11.81
LMT-50	Mix Tank Label	11.81

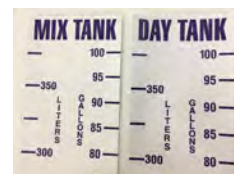

KENT METERS

PART NUMBER	PRODUCT DESCRIPTION	PRICE \$
KM-CA-CONV-KIT	Kent Meter to Carlon Meter	775.00
KM-CA-50	Carlon 1/2" Water Meter	367.33
KM-CA-75	Carlon 3/4" Water Meter	367.33
KM-CA-WL	Wire Lead for Meter	96.25



WAND

PART NUMBER	PRODUCT DESCRIPTION	PRICE \$
M-MXR-WD	Wand Assembly for 100 Gallon Tank	137.98
M-MXR-WB	Bicarb Wand Block for 100 Gallon Tank	19.95

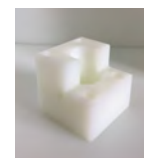

HYDROMETERS

PART NUMBER	PRODUCT DESCRIPTION	PRICE \$
HYDR-C-08265	Plastic Specific Gravity Hydrometer	165.95
HYDRO-E-6135-6	Hydrometer Jar 500 ml	59.95



MEDICAL SOLUTIONS INTERNATIONAL
 5646 MERRIAM DRIVE
 MERRIAM, KS 66203
www.medicalsolutionskc.com

800.326.5275
 913.438.9700
 FAX 913.438.9701

FUSES

PART NUMBER	PRODUCT DESCRIPTION	PRICE \$
FU-MXR-20	20 AMP Fuse (120 vt. sys)	39.98
FU-MXR-6.25	6.25 AMP Fuse (24 vt. sys)	39.98
FU-BU-FRN-R-2	Bullet Fuse	28.95
FU-BU-ECNR6.25	Bullet Fuse 6.25 AMP	28.95

SWITCHES

PART NUMBER	PRODUCT DESCRIPTION	PRICE \$
SWT-24RS	24 Volt Rocker Switch	13.43
SWT-120RS	120 Volt Rocker Switch	13.43
SWT-120TGL	120 Volt Toggle Switch SPST	13.43
SWT-53413-3	LED Green Indicator Light (Chlorine Timer)	13.43
SWT-53413-5	Green Indicator Light (Chlorine Timer)	13.43
SWT-53413-6	Green Indicator Light (MM1PD, Acid)	13.43
SWT-53415-5	Red Indicator Light (Chlorine Time,MM1PD)	13.43
SWT-35-0455	ON/OFF Large Round Push SPST	13.43
SWT-SS213	Momentary Contact N/O Switch	18.46
SWT-SS215-10	Push Button Switch Maintained	13.43

SENSORS

PART NUMBER	PRODUCT DESCRIPTION	PRICE \$
FS-5507027	Vertical Mount Level Switch	43.95
FS-5506011	Horizontal Float Switch Side Mount	49.95
FS-135815	Flow Sensor 1"	159.98

PROXIMITY SWITCH

PART NUMBER	PRODUCT DESCRIPTION	PRICE \$
SWT-PROX	Proximity Switch-Cole	399.36
SWT-PROX-H	Proximity Switch-Hartfiel	399.36

CIRCUIT BREAKER

PART NUMBER	PRODUCT DESCRIPTION	PRICE \$
CB-L881C	Circuit Breaker	38.95



TRANSFORMER

PART NUMBER	PRODUCT DESCRIPTION	PRICE \$
TR-120/24	Transformer 120 VT- 24 AC	65.95
TRC-150	120/24 Power Pack Switching Relay	65.95
SOLA-12549334	SOLA Transformer	195.85



STATIC INLINE MIXER

PART NUMBER	PRODUCT DESCRIPTION	PRICE \$
STATIC MIXER	Static Inline Mixer	186.75



ELECTRICAL CONTROL BOXES

PART NUMBER	PRODUCT DESCRIPTION	PRICE \$
M-RA02	Bicarb Remote Alarm with Reset Mute	641.25
M-MXR-BICFM	Dual Pump Control Acid	695.36
M-MXR-LTA	Low Tank Alarm	495.25
PP-24VT	Piezo Buzzer	17.48
M-CT02	Time Delay Chlorine Test Timer	608.33
M-RA03	Remote Alarm for Chlorine Test Timer	129.95

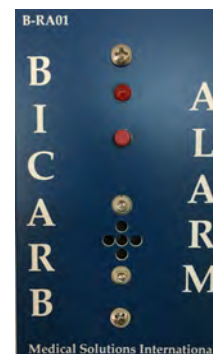

MEDICAL SOLUTIONS INTERNATIONAL
 5646 MERRIAM DRIVE
 MERRIAM, KS 66203
www.medicalsolutionskc.com

800.326.5275
 913.438.9700
 FAX 913.438.9701

PRESSURIZED PRODUCTS

23

PRESSURE GAUGE

PART NUMBER	PRODUCT DESCRIPTION	PRICE \$
PG-B254	Pressure Gauge Brass 0-100	80.66
PG-S-5335-100	Pressure Gauge Stainless Steel 0-100	118.73
PG-S-245CBM-30	Pressure Gauge Stainless Steel 0-30 Back Mount	118.73
PG-S-245CLM-30	Pressure Gauge Stainless Steel 0-30 Lower Mount	96.86



PRESSURE REGULATOR

PART NUMBER	PRODUCT DESCRIPTION	PRICE \$
PR-BHR	Pressure Regulator Bulkhead Nut	5.71
PR-R91S200AA	Pressure Regulator Norgren w/ 1/4" FNPT	58.64
PR-AAP044506	Pressure Regulator Watts w/ 1/4" FNPT	43.95
PR-R3621UY1-S1	Pressure Regulator AOP w/ 1/4" FNPT	51.65



PR-R91S200AA



PR-AAP044506



PR-R3621UY1-S1

MEDICAL SOLUTIONS INTERNATIONAL
5646 MERRIAM DRIVE
MERRIAM, KS 66203
www.medicalsolutionskc.com

800.326.5275
913.438.9700
FAX 913.438.9701

CAMLOCKS

PART NUMBER	PRODUCT DESCRIPTION	PRICE \$
CL-Q500558N	Camlock 1/2" X 3/4"	18.56
CL-DC75	Cap for 3/4" Male Camlock	8.16
CL-DC100	Cap for 1" Male Camlock	8.16
CL-Q500758-N	Camlock Barb X 3/4"MNPT	18.56
CL-Q50075F-N	Camlock Female X 3/4" MNPT	10.25
CL-Q890961260	Camlock Female X 3/4" Barb	14.62
CL-Q89096262	Camlock 3/4" Male X 3/4" Barb	14.62
CLQ-1314010	Camlock Dust Cover	16.13



BULKHEAD FITTINGS

PART NUMBER	PRODUCT DESCRIPTION	PRICE \$
BH-50	1/2" TXT Banjo Bulkhead Fitting	27.84
BH-75	3/4" TXT Banjo Bulkhead Fitting	29.62
BH-16439	1/2" White Bulkhead Fitting	39.56



FILTERS		
PART NUMBER	PRODUCT DESCRIPTION	PRICE \$
FIL-PO.2-10E	.2 Micron 10" RO Storage Tank Air Filter	129.95
FIL-DCP02000	.2 Micron Air Filter for Bicarb System	149.99
FIL-5-GAC-H	#5 Blue 1/2" Housing	28.75
FIL-5-GAC	Granulated Activated Carbon Filter	18.31
FIL-50H-SS	1/2" Clear Bulb, Filter Housing and Filter Screen	38.48
FIL-50-BH	1/2" Clear Bulb	28.50
FIL-50X100	Filter for 1/2" Housing	13.43
FIL-75H-SS	3/4" Clear Bulb, Filter Housing and Filter Screen	65.48
FIL-75-BH	3/4" Clear Bulb	38.50
FIL-75X100	Filter for 3/4" Housing	13.43
FIL-AP-5-10	10" 5 Micron Air Filter	6.95
FIL-AP-5-10/40	10" 5 Micron Air Filter (40 Per Case)	210.66
FIL-AP-5-20	20" 5 Micron Fines Filter (RO Feed)	7.95
FIL-AP-5-20/20	20" 5 Micron Case (20 Per case)	149.95
FIL-ACWP5BB-2	20" 5 Micron Blue Blue Filter	45.95
FIL-BB-5MIC	10" 5 Micron Blue Blue Filter	20.18
FIL-BB-50233	20" Filter Big Blue Housing	116.51
FIL-BB-AB0061	Bracket BB KIT White Steel	46.37
FIL-BB-AM4229	Coupler for BB Cartridge	2.49
FIL-BB-AW0296	Wrench SW-3 for BB Housing	9.45
FIL-BB-BB0R	Big Blue filter O Ring	6.35
FIL-BB-R20279	Poly wound 5 Micron Air Filter	20.25
FIL-CBC-10	10" Carbon Block Filter	20.25
FIL-CL6PF5	1/4" Inline Air Filter	22.88
FIL-HC/90-035	Hurricane Filter HC/90 -0.35 20"	201.15
FIL-K20260	20" Carbon Filters	24.36
FIL-K20272	10" CP 10 Micron Filter	6.75
FIL-R5	5" Particulate Filter	6.68



FIL-DCP02000



FIL-5-GAC-H



FIL-5-GAC



FIL-50H-SS



FIL-75H-SS

MEDICAL SOLUTIONS INTERNATIONAL
 5646 MERRIAM DRIVE
 MERRIAM, KS 66203
www.medicalsolutionskc.com

800.326.5275
 913.438.9700
 FAX 913.438.9701

IWAKI PUMP

PART NUMBER	PRODUCT DESCRIPTION	PRICE \$
PMP-IW-55RLT	Iwaki Pump 55 RLT	795.75
PMP-IW-55RLT-WEK	Iwaki Pump Wet End Kit-55 RLT	380.75
PMP-IW-70RLZT	Iwaki Pump MD 70 RLZT	982.08
PMP-IW-70RLTZ-WEK	Iwaki Pump Wet End Kit-70 RLZT	586.58
PMP-IW-30RLT	Iwaki Pump 30 RLT	524.43
PMP-IW-30RLT-WEK	Iwaki Pump Wet End Kit 30 RLT	270.33

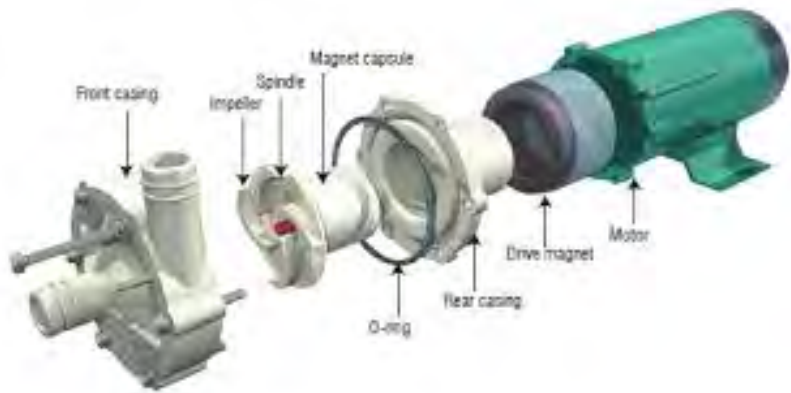

MEDICAL SOLUTIONS INTERNATIONAL
 5646 MERRIAM DRIVE
 MERRIAM, KS 66203
www.medicalsolutionskc.com

800.326.5275
 913.438.9700
 FAX 913.438.9701

MARCH PUMP TE-7R

PART NUMBER	DIAGRAM #	PRODUCT DESCRIPTION	PRICE \$
PMP-M-TE7R		TE7R Large March Pump	1199.00
PMP-M-TE7R-WEK	#1- #8	TE7R Wet End Kit	549.98
PMP-M-0011-10	#3	Front Housing TE7R	228.25
PMP-M-0010-10	#4	Viton O-RING TE7R	33.75
PMP-M-0009-10	#5	Ceramic Washer TE7R	12.19
PMP-M-0039-10	#6	Ceramic Spindle TE7R	49.98
PMP-M-0159-05	#7	Impellar Assembly TE7R	289.58
PMP-M-0067-01	#8	Rear Magnet Housing TE7R	193.55
PMP-M-0124-01	ALT #8	Rear Magnet Housing Kynar	215.55
PMP-M-0130-02	#9	Drive Magnet Housing Assembly TE7R	429.17
PMP-M-0092-01	#10	Motor to Pump Bracket TE7R	141.75
PMP-M-0016-14	#11	Motor TE7R	883.58

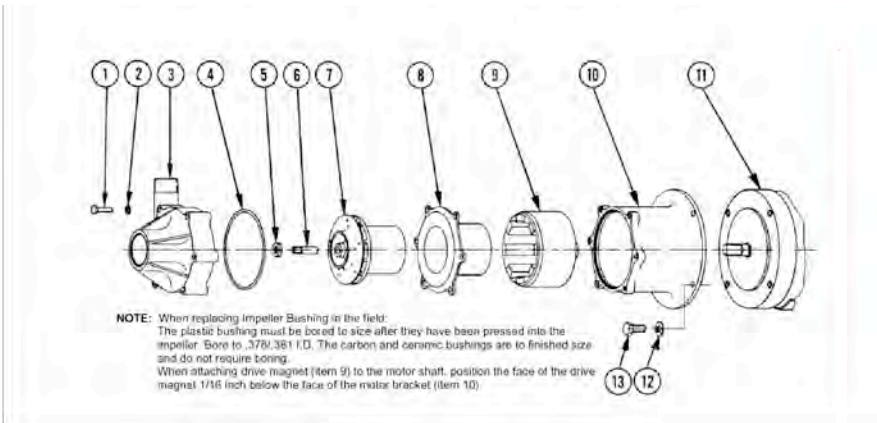

MEDICAL SOLUTIONS INTERNATIONAL
 5646 MERRIAM DRIVE
 MERRIAM, KS 66203
www.medicalsolutionskc.com

800.326.5275
 913.438.9700
 FAX 913.438.9701

HOSE AND HOSE CLAMPS		
PART NUMBER	PRODUCT DESCRIPTION	PRICE \$
HC-100	Hose Clamp for 1" Hose OD	2.74
HC-3/4	Hose Clamp for 3/4" Hose OD	2.74
HC-1/2	Hose Clamp for 1/2" Hose OD	2.74
HC-3/8	Hose Clamp for 3/8" Hose OD	2.74
HC-BLACK	Black Hose Clamp for 3/8" OD	2.38
H-PB-1" POLY	1" Poly Braided Hose	2.74
H-PB-3/4" POLY	3/4" Poly Braided Hose	2.74
H-PB-1/2" POLY	1/2" Poly Braided Hose	2.74
H-PB-3/8" POLY	3/8" Poly Braided Hose	2.74
H-PV-75	3/4" Clear Poly Vinyl Hose	2.74
H-PV-3/8	3/8" Clear Poly Vinyl Hose	2.74



CLICKS		
PART NUMBER	PRODUCT DESCRIPTION	PRICE \$
CLIC-12	#12 Click for Drain Hose	1.85
CLIC-15	#15 Click for Drain Hose	1.85
CLIC-17	#17 Click for 3/8" PVC	1.95
CLIC-20	#20 Click for 1/2" PVC	2.78
CLIC-25	#25 Click for 3/4" PVC	3.44
CLIC-32	#32 Click for 1" PVC	4.86
CLIC-47	#47 Click for 1 1/2" PVC	7.76
CLIC-59	#59 Click for 2" PVC	9.38
CLIC-ARL-22	#22 Click for prime Drain Funnels	2.98



MEDICAL SOLUTIONS INTERNATIONAL
 5646 MERRIAM DRIVE
 MERRIAM, KS 66203
www.medicalsolutionskc.com

800.326.5275
 913.438.9700
 FAX 913.438.9701

TUBING		
PART NUMBER	PRODUCT DESCRIPTION	PRICE \$
1/2" BLUE	1/2" Poly Tubing Blue	0.66
1/2" ORANGE	1/2" Poly Tubing Orange	0.66
1/2" RED	1/2" Poly Tubing Red	0.66
1/2" YELLOW	1/2" Poly Tubing Yellow	0.66
1/4" BLACK	1/4" Poly Tubing Black	0.66
1/4" BLUE	1/4" Poly Tubing Blue	0.66
1/4" RED	1/4" Poly Tubing Red	0.66
1/4" YELLOW	1/4" Poly Tubing Yellow	0.66
1/4" WHITE	1/4" Poly Tubing White	0.66
3/8" BLUE	3/8" Poly Tubing Blue	0.65
3/8" GREEN	3/8" Poly Tubing Green	0.65
3/8" ORANGE	3/8" Poly Tubing Orange	0.65
3/8" RED	3/8" Poly Tubing Red	0.65
3/8" WHITE	3/8 Poly Tubing White	0.65
3/8" YELLOW	3/8" Poly Tubing Yellow	0.65
5/8" YELLOW	5/8" Poly Tubing Yellow	0.85
5/8" BLUE	5/8" Poly Tubing Blue	0.85
5/8" RED	5/8" Poly Tubing Red	0.85



COILED CONCENTRATED TUBING		
PART NUMBER	PRODUCT DESCRIPTION	PRICE \$
C80550	Red Coiled Concentrated Tubing	16.95
C80553	Blue Coiled Concentrated Tubing	16.95
C80558	Clear Coiled Concentrated Tubing	16.95



MEDICAL SOLUTIONS INTERNATIONAL
 5646 MERRIAM DRIVE
 MERRIAM, KS 66203
www.medicalsolutionskc.com

800.326.5275
 913.438.9700
 FAX 913.438.9701

COUPLING SOC

PART NUMBER	PRODUCT DESCRIPTION	PRICE \$
829-002	1/4" SXS Coupling	8.54
829-003	3/8" SXS Coupling	8.54
829-005	1/2" SXS Coupling	5.87
829-007	3/4" SXS Coupling	7.68
829-010	1" SXS Coupling	7.95
829-012	1-1/4" SXS Coupling	12.45
829-015	1-1/2" SXS Coupling	13.52
829-020	2" SXS Coupling	13.83



FEMALE ADAPTER SOC X FIPT

PART NUMBER	PRODUCT DESCRIPTION	PRICE \$
835-002	1/4" SXT Female Adapter	8.83
835-003	3/8" SXT Female Adapter	8.94
835-005	1/2" SXT Female Adapter	5.45
835-007	3/4" SXT Female Adapter	7.43
835-010	1" SXT Female Adapter	10.95
835-012	1-1/4" SXT Female Adapter	17.74
835-015	1-1/2" SXT Female Adapter	21.74
835-020	2" SXT Female Adapter	37.94



MALE ADAPTER MIPT X SOC

PART NUMBER	PRODUCT DESCRIPTION	PRICE \$
836-005	1/2" SXT Male Adapter	6.86
836-007	3/4" SXT Male Adapter	7.57
836-010	1" SXT Male Adapter	12.91
836-012	1-1/4" SXT Male Adapter	17.74
836-015	1-1/2" SXT Male Adapter	19.96
836-020	2" SXT Male Adapter	28.94



COUPLING FIPT

PART NUMBER	PRODUCT DESCRIPTION	PRICE \$
830-002	1/4" TXT Coupling	5.99
830-003	3/8" TXT Coupling	6.56
830-005	1/2" TXT Coupling	5.48
830-007	3/4" TXT Coupling	8.52
830-010	1" TXT Coupling	9.86
830-012	1-1/4" TXT Coupling	10.56
830-015	1-1/2" TXT Coupling	25.68
830-020	2" TXT Coupling	26.73



90° ELBOW SOC

PART NUMBER	PRODUCT DESCRIPTION	PRICE \$
806-002	1/4" SXS 90° Elbow	2.95
806-003	3/8" SXS 90° Elbow	2.98
806-005	1/2" SXS 90° Elbow	3.25
806-007	3/4" SXS 90° Elbow	3.97
806-010	1" SXS 90° Elbow	4.65
806-012	1-1/4" SXS 90° Elbow	8.71
806-015	1-1/2" SXS 90° Elbow	9.58
806-020	2" SXS 90° Elbow	10.53



90° ELBOW LONG SWEEP SOC

PART NUMBER	PRODUCT DESCRIPTION	PRICE \$
806-005LSF	1/2" SXS 90° Long Sweep	25.51
806-007LFS	3/4" SXS 90° Long Sweep	28.63
806-010LSF	1" SXS 90° Long Sweep	32.92
806-012LSF	1-1/4" SXS 90° Long Sweep	54.13
806-015LSF	1-3/4" SXS 90° Long Sweep	54.82
806-020LSF	2" SXS 90° Long Sweep	59.27



MEDICAL SOLUTIONS INTERNATIONAL
 5646 MERRIAM DRIVE
 MERRIAM, KS 66203
www.medicalsolutionskc.com

800.326.5275
 913.438.9700
 FAX 913.438.9701

90° ELBOW SWEEP SOC X SOC

PART NUMBER	PRODUCT DESCRIPTION	PRICE \$
806-005S	1/2" SXS 90° Sweep	7.36
806-007S	3/4" SXS 90° Sweep	10.48
806-010S	1" SXS 90° Sweep	15.35
806-012S	1-1/4" SXS 90° Sweep	19.93
806-015S	1-3/4" SXS 90° Sweep	21.82
806-020S	2" SXS 90° Sweep	26.43



90° SOC X FIPT

PART NUMBER	PRODUCT DESCRIPTION	PRICE \$
807-002	1/4" SXT 90° Elbow	11.61
807-003	3/8" SXT 90° Elbow	11.61
807-005	1/2" SXT 90° Elbow	12.77
807-007	3/4" SXT 90° Elbow	14.66
807-010	1" SXT 90° Elbow	14.77
807-012	1-1/4" SXT 90° Elbow	16.03
807-015	1-1/2" SXT 90° Elbow	20.31
807-020	2" SXT 90° Elbow	26.32



90° ELBOW FIPT

PART NUMBER	PRODUCT DESCRIPTION	PRICE \$
808-002	1/4" TXT 90° Elbow	6.53
808-003	3/8" TXT 90° Elbow	7.32
808-005	1/2" TXT 90° Elbow	7.51
808-007	3/4" TXT 90° Elbow	8.97
808-010	1" TXT 90° Elbow	11.78
808-012	1-1/4" TXT 90° Elbow	11.53
808-015	1-1/2" TXT 90° Elbow	16.36
808-020	2" TXT 90° Elbow	18.43



MEDICAL SOLUTIONS INTERNATIONAL
 5646 MERRIAM DRIVE
 MERRIAM, KS 66203
www.medicalsolutionskc.com

800.326.5275
 913.438.9700
 FAX 913.438.9701

90° STREET ELBOW SPRIG X SOC

PART NUMBER	PRODUCT DESCRIPTION	PRICE \$
809-005	1/2" 90° Street Elbow	3.96
809-007	3/4" 90° Street Elbow	5.72
809-010	1" 90° Street Elbow	8.46
809-012	1-1/4" 90° Street Elbow	10.91
809-015	1-1/2" 90° Street Elbow	11.43
809-020	2" 90° Street Elbow	13.88



45° ELBOW SOC

PART NUMBER	PRODUCT DESCRIPTION	PRICE \$
817-002	1/4" SXS 45° Elbow	9.43
817-003	3/8" SXS 45° Elbow	10.69
817-005	1/2" SXS 45° Elbow	5.56
817-007	3/4" SXS 45° Elbow	8.94
817-010	1" SXS 45° Elbow	13.98
817-012	1-1/4" SXS 45° Elbow	16.34
817-015	1-1/2" SXS 45° Elbow	19.71
817-020	2" SXS 45° Elbow	24.85



45° ELBOW FIPT

PART NUMBER	PRODUCT DESCRIPTION	PRICE \$
819-002	1/4" TXT 45° Elbow	11.98
819-003	3/8" TXT 45° Elbow	8.92
819-005	1/2" TXT 45° Elbow	11.97
819-007	3/4" TXT 45° Elbow	12.79
819-010	1" TXT 45° Elbow	14.79
819-012	1-1/4" TXT 45° Elbow	17.56
819-015	1-1/2" TXT 45° Elbow	19.36
819-020	2" TXT 45° Elbow	29.96



45° STREET ELBOW SPIG X SOC

PART NUMBER	PRODUCT DESCRIPTION	PRICE \$
827-005	1/2" 45° Street Elbow	5.56
827-007	3/4" 45° Street Elbow	8.49
827-010	1" 45° Street Elbow	12.73
827-012	1-1/4" 45° Street Elbow	16.21
827-015	1-1/2" 45° Street Elbow	19.17
827-020	2" 45° Street Elbow	24.85



TEE SOC

PART NUMBER	PRODUCT DESCRIPTION	PRICE \$
801-002	1/4" SXSXS Tee	8.96
801-003	3/8" SXSXS Tee	8.96
801-005	1/2" SXSXS Tee	8.66
801-007	3/4" SXSXS Tee	9.56
801-010	1" SXSXS Tee	11.98
801-012	1-1/4" SXSXS Tee	29.98
801-015	1-1/2" SXSXS Tee	29.98
801-020	2" SXSXS Tee	37.78



TEE SOC X FIPT

PART NUMBER	PRODUCT DESCRIPTION	PRICE \$
802-002	1/4" SXSXT Tee	18.24
802-005	1/2" SXSXT Tee	14.26
802-007	3/4" SXSXT Tee	18.63
802-010	1" SXSXT Tee	19.93
802-012	1-1/4" SXSXT Tee	21.31
802-015	1-1/2" SXSXT Tee	25.28
802-020	2" SXSXT Tee	30.87



MEDICAL SOLUTIONS INTERNATIONAL
5646 MERRIAM DRIVE
MERRIAM, KS 66203
www.medicalsolutionskc.com

800.326.5275
913.438.9700
FAX 913.438.9701

TEE FIPT

PART NUMBER	PRODUCT DESCRIPTION	PRICE \$
805-002	1/4" TXTXT Tee	10.58
805-003	3/8" TXTXT Tee	10.58
805-005	1/2" TXTXT Tee	10.58
805-007	3/4" TXTXT Tee	11.78
805-010	1" TXTXT Tee	19.41
805-012	1-1/4" TXTXT Tee	23.52
805-015	1-1/2" TXTXT Tee	21.38
805-020	2" TXTXT Tee	23.66



CROSS SOC

PART NUMBER	PRODUCT DESCRIPTION	PRICE \$
820-002	1/4" SXS Cross	40.92
820-005	1/2" SXS Cross	40.92
820-007	3/4" SXS Cross	43.17
820-010	1" SXS Cross	47.56
820-012	1-1/4" SXS Cross	49.66
820-015	1-1/2" SXS Cross	65.59
820-020	2" SXS Cross	79.97



CAP SOC

PART NUMBER	PRODUCT DESCRIPTION	PRICE \$
847-002	1/4" Cap Socket	6.79
847-003	3/8" Cap Socket	6.79
847-005	1/2" Cap Socket	5.23
847-007	3/4" Cap Socket	5.51
847-010	1" Cap Socket	9.79
847-012	1-1/4" Cap Socket	11.81
847-015	1-1/2" Cap Socket	11.81
847-020	2" Cap Socket	23.31



PVC SCHEDULE 80 FITTINGS

36

CAP FIPT		
PART NUMBER	PRODUCT DESCRIPTION	PRICE \$
848-002	1/4" Threaded Cap	6.53
848-003	3/8" Threaded Cap	6.53
848-005	1/2" Threaded Cap	5.82
848-007	3/4" Threaded Cap	7.89
848-010	1" Threaded Cap	9.22
848-012	1-1/4" Threaded Cap	10.98
848-015	1-1/2" Threaded Cap	12.54
848-020	2" Threaded Cap	19.64



PLUG SPIG		
PART NUMBER	PRODUCT DESCRIPTION	PRICE \$
849-005	1/2" SPIG Plug	4.89
849-007	3/4" SPIG Plug	5.44
849-010	1" SPIG Plug	6.14
849-012	1-1/4" SPIG Plug	7.83
849-015	1-1/2" SPIG Plug	8.59
849-020	2" SPIG Plug	11.36



PLUG MIPT		
PART NUMBER	PRODUCT DESCRIPTION	PRICE \$
850-002	1/4" Threaded Plug	5.84
850-003	3/8" Threaded Plug	5.84
850-005	1/2" Threaded Plug	5.46
850-007	3/4" Threaded Plug	5.75
850-010	1" Threaded Plug	6.42
850-012	1-1/4" Threaded Plug	7.81
850-015	1-1/2" Threaded Plug	11.53
850-020	2" Threaded Plug	9.67



MEDICAL SOLUTIONS INTERNATIONAL
 5646 MERRIAM DRIVE
 MERRIAM, KS 66203
www.medicalsolutionskc.com

800.326.5275
 913.438.9700
 FAX 913.438.9701

REDUCER BUSHING FLUSH SPIG X SOC

PART NUMBER	PRODUCT DESCRIPTION	PRICE \$
RB-837-052	3/8" X 1/4" SXS Reducer Bushing	4.72
RB-837-072	1/2" X 1/4" SXS Reducer Bushing	4.72
RB-837-073	1/2" X 3/8" SXS Reducer Bushing	4.72
RB-837-101	3/4" X 1/2" SXS Reducer Bushing	4.89
RB-837-129	1" X 3/8" SXS Reducer Bushing	9.83
RB-837-130	1" X 1/2" SXS Reducer Bushing	4.93
RB-837-131	1" X 3/4" SXS Reducer Bushing	5.42
RB-837-166	1-1/4" X 1/2" SXS Reducer Bushing	7.73
RB-837-167	1-1/4" X 3/4" SXS Reducer Bushing	7.73
RB-837-168	1-1/4" X 1" SXS Reducer Bushing	7.73
RB-837-209	1-1/2" X 1/2" SXS Reducer Bushing	10.53
RB-837-210	1-1/2" X 3/4" SXS Reducer Bushing	10.53
RB-837-211	1-1/2" X 1" SXS Reducer Bushing	11.58
RB-837-212	1-1/2" X 1-1/4" SXS Reducer Bushing	10.53
RB-837-247	2" X 1/2" SXS Reducer Bushing	14.93
RB-837-248	2" X 3/4" SXS Reducer Bushing	14.93
RB-837-249	2" X 1" SXS Reducer Bushing	14.93
RB-837-250	2" X 1-1/4" SXS Reducer Bushing	14.93
RB-837-251	2" X 1/2" SXS Reducer Bushing	14.93
RB-837-290	2-1/2" X 1-1/4" SXS Reducer Bushing	25.95
RB-837-291	2-1/2" X 1-1/2" SXS Reducer Bushing	25.95
RB-837-292	2-1/2" X 2" SXS Reducer Bushing	25.95

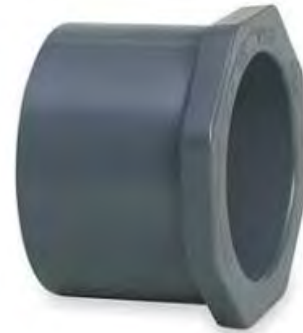

REDUCER BUSHING FLUSH SPIG X FIPT		
PART NUMBER	PRODUCT DESCRIPTION	PRICE \$
RB-838-052	3/8"X1/4" SXT Reducer Bushing	4.72
RB-838-071	1/2"X1/8" SXT Reducer Bushing	4.72
RB-838-072	1/2"X1/4" SXT Reducer Bushing	5.79
RB-838-073	1/2"X3/8" SXT Reducer Bushing	5.72
RB-838-098	3/4"X1/4" SXT Reducer Bushing	4.56
RB-838-099	3/4"X3/8" SXT Reducer Bushing	7.93
RB-838-101	3/4"X1/2" SXT Reducer Bushing	3.72
RB-838-127	1"X1/8" SXT Reducer Bushing	4.93
RB-838-129	1"X3/8" SXT Reducer Bushing	9.85
RB-838-130	1"X1/2" SXT Reducer Bushing	4.93
RB-838-131	1"X3/4" SXT Reducer Bushing	5.42
RB-838-166	1-1/4"X1/2" SXT Reducer Bushing	9.92
RB-838-167	1-1/4"X3/4" SXT Reducer Bushing	9.92
RB-838-168	1-1/4"X1" SXT Reducer Bushing	9.92
RB-838-206	1-1/2"X1/8" SXT Reducer Bushing	12.54
RB-838-207	1-1/2"X1/4" SXT Reducer Bushing	12.91
RB-838-209	1-1/2"X1/2" SXT Reducer Bushing	12.54
RB-838-210	1-1/2"X3/4" SXT Reducer Bushing	12.54
RB-838-211	1-1/2"X1" SXT Reducer Bushing	13.79
RB-838-212	1-1/2"X1-1/4" SXT Reducer Bushing	12.54
RB-838-247	2"X1/2" SXT Reducer Bushing	15.34
RB-838-248	2"X3/4" SXT Reducer Bushing	15.34
RB-838-249	2"X1" SXT Reducer Bushing	15.34
RB-838-250	2"X1-1/4" SXT Reducer Bushing	15.34
RB-838-251	2"X1/2" SXT Reducer Bushing	15.34



MEDICAL SOLUTIONS INTERNATIONAL
 5646 MERRIAM DRIVE
 MERRIAM, KS 66203
www.medicalsolutionskc.com

800.326.5275
 913.438.9700
 FAX 913.438.9701

REDUCER BUSHING FLUSH MIPT X FIPT

PART NUMBER	PRODUCT DESCRIPTION	PRICE \$
TRB-839-041	1/4" X 1/8" TXT Reducer Bushing	11.84
TRB-839-052	3/8" X 1/4" TXT Reducer Bushing	11.84
TRB-839-072	1/2" X 1/4" TXT Reducer Bushing	11.84
TRB-839-073	1/2" X 3/8" TXT Reducer Bushing	11.84
TRB-839-098	3/4" X 1/4" TXT Reducer Bushing	8.77
TRB-839-099	3/4" X 3/8" TXT Reducer Bushing	8.77
TRB-839-101	3/4" X 1/2" TXT Reducer Bushing	6.61
TRB-839-128	1" X 1/4" TXT Reducer Bushing	14.23
TRB-839-129	1" X 3/8" TXT Reducer Bushing	9.35
TRB-839-130	1" X 1/2" TXT Reducer Bushing	11.39
TRB-839-131	1" X 3/4" TXT Reducer Bushing	11.39
TRB-839-166	1-1/4" X 1/2" TXT Reducer Bushing	11.98
TRB-839-167	1-1/4" X 3/4" TXT Reducer Bushing	11.98
TRB-839-168	1-1/4" X 1" TXT Reducer Bushing	11.98
TRB-839-209	1-1/2" X 1/2" TXT Reducer Bushing	12.96
TRB-839-210	1-1/2" X 3/4" TXT Reducer Bushing	14.26
TRB-839-211	1-1/2" X 1" TXT Reducer Bushing	14.26
TRB-839-212	1-1/2" X 1-1/4" TXT Reducer Bushing	14.26
TRB-839-247	2" X 1/2" TXT Reducer Bushing	18.98
TRB-839-248	2" X 3/4" TXT Reducer Bushing	19.98
TRB-839-249	2" X 1" TXT Reducer Bushing	18.98
TRB-839-250	2" X 1-1/4" TXT Reducer Bushing	18.98
TRB-839-251	2" X 1/2" TXT Reducer Bushing	18.98
TRB-839-292	2-1/2" X 2" TXT Reducer Bushing	25.81



UNION (OLD STYLE) FIPT W/EDPM O-RING SEAL

PART NUMBER	PRODUCT DESCRIPTION	PRICE \$
898-005	1/2" Threaded Union EPDM	13.79
898-007	3/4" Threaded Union EPDM	19.29
898-010	1" Threaded Union EPDM	25.70
898-012	1-1/4" Socket Union EDPM	44.56
898-015	1-1/2" Socket Union EDPM	55.17
898-020	2" Socket Union EDPM	84.89

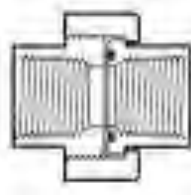
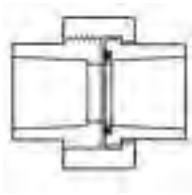

UNION (OLD STYLE) SOC W/EDPM O-RING SEAL

PART NUMBER	PRODUCT DESCRIPTION	PRICE \$
897-005	1/2" Socket Union EPDM	11.87
897-007	3/4" Socket Union EPDM	14.73
897-010	1" Socket Union EPDM	17.29
897-012	1-1/4" Socket Union EDPM	34.28
897-015	1-1/2" Socket Union EDPM	38.79
897-020	2" Socket Union EDPM	47.84
897-025	2 1/2" Socket Union EDPM	76.05
897-030	3" Socket Union EDPM	89.02
897-040	4" Socket Union EDPM	123.13



MEDICAL SOLUTIONS INTERNATIONAL
5646 MERRIAM DRIVE
MERRIAM, KS 66203
www.medicalsolutionskc.com

800.326.5275
913.438.9700
FAX 913.438.9701

PVC SCHEDULE 80 FITTINGS

41

TANK ADAPTER WITH EDPM GASKET SOC X F

PART NUMBER	PRODUCT DESCRIPTION	PRICE \$
871-E-005	1/2" SXT Bulkhead	34.79
871-E-007	3/4" SXT Bulkhead	35.65
871-E-010	1" SXT Bulkhead	42.99
871-E-012	1-1/4" SXT Bulkhead	50.88
871-E-015	1-1/2" SXT Bulkhead	55.66
871-E-020	2" SXT Bulkhead	81.91

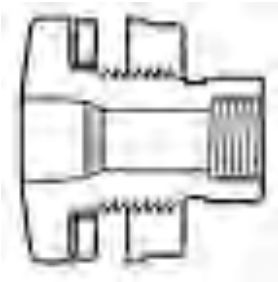

TANK ADAPTER WITH EDPM GASKET FIPT

PART NUMBER	PRODUCT DESCRIPTION	PRICE \$
872-E-005	1/2" TXT Bulkhead	42.42
872-E-007	3/4" TXT Bulkhead	46.05
872-E-010	1" TXT Bulkhead	54.71
872-E-012	1-1/4" TXT Bulkhead	71.91
872-E-015	1-1/2" TXT Bulkhead	77.78
872-E-020	2" TXT Bulkhead	101.74

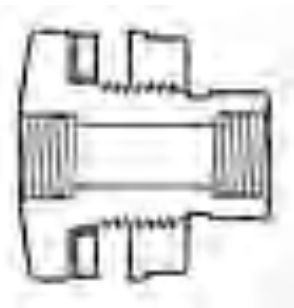

BULKHEAD FITTINGS

PART NUMBER	PRODUCT DESCRIPTION	PRICE \$
BH-50	1/2" TXT Banjo Bulkhead Fitting	27.84
BH-75	3/4" TXT Banjo Bulkhead Fitting	29.62
BH-16439	1/2" White Bulkhead	39.56



MEDICAL SOLUTIONS INTERNATIONAL
5646 MERRIAM DRIVE
MERRIAM, KS 66203
www.medicalsolutionskc.com

800.326.5275
913.438.9700
FAX 913.438.9701

NIPPLES 1/4"

PART NUMBER	PRODUCT DESCRIPTION	PRICE \$
880-005	Close 1/4" NIPPLE	0.92
880-015	1-1/2" Long 1/4" Nipple	0.99
880-020	2" Long 1/4" Nipple	0.99
880-025	2-1/2" Long 1/4" Nipple	1.47
880-030	3" Long 1/4" Nipple	1.47



NIPPLES 3/8"

PART NUMBER	PRODUCT DESCRIPTION	PRICE \$
881-005	Close 3/8" Nipple	0.92
881-015	1-1/2" Long 3/8" Nipple	0.92
881-020	2" Long 3/8" Nipple	0.98
881-025	2-1/2" Long 3/8" Nipple	1.47
881-030	3" Long 3/8" Nipple	1.47



NIPPLES 1/2"

PART NUMBER	PRODUCT DESCRIPTION	PRICE \$
882-005	Close 1/2" Nipple	1.98
882-015	1-1/2" Long 1/2" Nipple	1.98
882-020	2" Long 1/2" Nipple	1.98
882-025	2-1/2" Long 1/2" Nipple	1.98
882-030	3" Long 1/2" Nipple	2.36
882-035	3-1/2" Long 1/2" Nipple	2.36
882-040	4" Long 1/2" Nipple	2.47
882-045	4-1/2" Long 1/2" Nipple	2.49
882-050	5" Long 1/2" Nipple	2.55
882-055	5-1/2" Long 1/2" Nipple	2.55
882-060	6" Long 1/2" Nipple	2.63
882-060M	6" Long 1/2" Nipple Machine Cut	6.35



MEDICAL SOLUTIONS INTERNATIONAL
5646 MERRIAM DRIVE
MERRIAM, KS 66203
www.medicalsolutionskc.com

800.326.5275
913.438.9700
FAX 913.438.9701

NIPPLES 3/4"

PART NUMBER	PRODUCT DESCRIPTION	PRICE \$
883-005	Close 3/4" Nipple	1.98
883-015	1-1/2" Long 3/4" Nipple	1.98
883-020	2" Long 3/4" Nipple	1.98
883-025	2-1/2" Long 3/4" Nipple	2.36
883-030	3" Long 3/4" Nipple	2.47
883-035	3-1/2" Long 3/4" Nipple	2.42
883-040	4" Long 3/4" Nipple	2.49
883-045	4-1/2" Long 3/4" Nipple	2.63
883-050	5" Long 3/4" Nipple	2.77
883-055	5-1/2" Long 3/4" Nipple	3.45
883-060	6" Long 3/4" Nipple	3.63
883-140	14" Long X 3/4" Nipple Machine	4.85



NIPPLES 1"

PART NUMBER	PRODUCT DESCRIPTION	PRICE \$
884-005	Close 1" Nipple	2.69
884-015	1-1/2" Long 1" Nipple	2.71
884-020	2" Long 1" Nipple	2.71
884-025	2-1/2" Long 1" Nipple	2.79
884-030	3" Long 1" Nipple	2.77
884-035	3-1/2" Long 1" Nipple	2.89
884-040	4" Long 1" Nipple	3.15
884-045	4-1/2" Long 1" Nipple	3.22
884-050	5" Long 1" Nipple	3.44
884-055	5-1/2" Long 1" Nipple	3.72
884-060	6" Long 1" Nipple	3.99



MEDICAL SOLUTIONS INTERNATIONAL
5646 MERRIAM DRIVE
MERRIAM, KS 66203
www.medicalsolutionskc.com

800.326.5275
913.438.9700
FAX 913.438.9701

NIPPLES 1-1/4"

PART NUMBER	PRODUCT DESCRIPTION	PRICE \$
885-005	Close 1-1/4" Nipple	2.33
885-015	1-1/2" Long 1-1/4" Nipple	2.36
885-020	2" Long 1-1/4" Nipple	2.39
885-025	2-1/2" Long 1-1/4" Nipple	2.39
885-030	3" Long 1-1/4" Nipple	2.61
885-035	3-1/2" Long 1-1/4" Nipple	2.72
885-040	4" Long 1-1/4" Nipple	2.72
885-045	4-1/2" Long 1-1/4" Nipple	2.97
885-050	5" Long 1-1/4" Nipple	2.97
885-055	5-1/2" Long 1-1/4" Nipple	4.48
885-060	6" Long 1-1/4" Nipple	4.48



NIPPLES 1-1/2"

PART NUMBER	PRODUCT DESCRIPTION	PRICE \$
886-005	Close 1-1/2" Nipple	4.59
886-015	1-1/2" Long 1-1/2" Nipple	4.34
886-020	2" Long 1-1/2" Nipple	4.68
886-025	2-1/2" Long 1-1/2" Nipple	4.85
886-030	3" Long 1-1/2" Nipple	4.96
886-035	3-1/2" Long 1-1/2" Nipple	5.76
886-040	4" Long 1-1/2" Nipple	5.76
886-045	4-1/2" Long 1-1/2" Nipple	5.91
886-050	5" Long 1-1/2" Nipple	5.91
886-055	5-1/2" Long 1-1/2" Nipple	8.43
886-060	6" Long 1-1/2" Nipple	11.34



MEDICAL SOLUTIONS INTERNATIONAL
5646 MERRIAM DRIVE
MERRIAM, KS 66203
www.medicalsolutionskc.com

800.326.5275
913.438.9700
FAX 913.438.9701

BALL VALVES		
PART NUMBER	PRODUCT DESCRIPTION	PRICE \$
BV-3624-007	3/4" True Union Ball Valve	49.38
BV-3624-010	1" True Union Ball Valve	78.59
BV-2121-005	1/2" Compact Ball Valve TXT	24.57
BV-2121-010	1" Compact Ball Valve TXT	36.61
BV-2122-005	1/2" Compact Ball Valve SXS	24.57
BV-2122-007	3/4" Compact Ball Valve SXS	33.41
BV-2122-010	1" Compact Ball Valve SXS	36.61
BV-2264F4MB	1/4" Female Thread X Male Barb Labcock Ball Valve	36.95
BV-2621-005G	1/2" Utility Ball Valve TXT (GRAY)	22.34
BV-2621-005W	1/2" Sample Port Ball Valve TXT (WHITE)	22.34
BV-2621-SAMPLE	1/2" Sample Port Ball Valve Set up	31.24
BV-6621-007	3/4" Compact Ball Valve TXT	38.41
BV-6622-007	3/4" Compact Ball Valve SXS	38.41
BV-A1210-015	1 1/2" ASHAI True Union Ball Valve	109.95
BV-ASHAI-3WAY	ASHAI 3 WAY 1/2" Ball Valve Tee TYPE 23	178.07
BV-PVC-350E	Ball Valve 1/2" 3 WAY	55.68
BV-SMC-25FF	Ball Valve 1/4" Female NPT X 1/4" Female NPT	15.95
BV-SMC-25MF	Ball Valve 1/4" Male NPT X 1/4" Female NPT	15.95



MEDICAL SOLUTIONS INTERNATIONAL
 5646 MERRIAM DRIVE
 MERRIAM, KS 66203
www.medicalsolutionskc.com

800.326.5275
 913.438.9700
 FAX 913.438.9701

CHECK VALVES

PART NUMBER	PRODUCT DESCRIPTION	PRICE \$
CV-4529-005	1/2" Check Valve True Union Ball Check	35.75
CV-4529-007	3/4" Check Valve True Union Ball Check	53.19
CV-4529-010	1" Check Valve True Union Ball Check	74.43
CV-4529-015	1 1/2" Check Valve True Union Ball Check	124.69
CV-6858F8F-E	1/2" Check Valve Black	16.26
CV-68712F12F	3/4" Check Valve Black	19.22
CV-3M3M	PVDF Inline Check Valve	8.95



GATE VALVES

PART NUMBER	PRODUCT DESCRIPTION	PRICE \$
GV-2021-005	1/2" Threaded Gate Valve	52.98
GV-2021-010	1" Threaded Gate Valve	98.53
GV-2022-005	1/2" Socket Gate Valve	48.26
GV-2022-010	1" Socket Gate Valve	98.53

MEDICAL SOLUTIONS INTERNATIONAL
5646 MERRIAM DRIVE
MERRIAM, KS 66203
www.medicalsolutionskc.com

800.326.5275
913.438.9700
FAX 913.438.9701

BARBED FITTINGS

47

PVC		
PART NUMBER	PRODUCT DESCRIPTION	PRICE \$
HB-325HB-4-4PP	1/4" Male NPT x 1/4" Barb (black P4MCB4)	1.38
1407-010	1" Female NPT X 1" Barb Elbow	2.89
1407-131	3/4" Male NPT X 1" Barb Elbow	3.99
1413-007	3/4" Male NPT X 3/4" Barb Elbow	4.89
1413-010	1" Male NPT X 1" Barb Elbow	5.71
1413-101	1/2" Male NPT X 3/4" Barb Elbow	6.72
1435-007	3/4" Female NPT X 3/4" Barb Elbow	4.53
1436-007	3/4" Male NPT X 3/4" Barb Straight	2.89
1436-010	1" Male NPT X 1" Barb Straight	2.89
1436-102	3/4" Male NPT X 1" Barb Straight	2.96
1436-131	1" Male NPT X 3/4" Barb Straight	2.89
1436-074	1/2" Male NPT X 3/4" Barb Straight	5.78



POLYPROPYLENE FITTINGS		
PART NUMBER	PRODUCT DESCRIPTION	PRICE \$
POLY-64822	1/2" Male NPT X 3/8" Barb Straight	1.82
POLY-64489	1/2" Male NPT X 3/8" Barb Elbow	1.82



CUSTOM FAUCET		
PART NUMBER	PRODUCT DESCRIPTION	PRICE \$
PVC-80-005	1/2" Formed Faucet	14.77



MEDICAL SOLUTIONS INTERNATIONAL
 5646 MERRIAM DRIVE
 MERRIAM, KS 66203
www.medicalsolutionskc.com

800.326.5275
 913.438.9700
 FAX 913.438.9701



GARDEN HOSE THREAD BODY POLYSULFONE (white)

PART NUMBER	FLOW	PRODUCT DESCRIPTION	PRICE \$
QD-HFCD101235GHT	3/8"	3/4" MGHT PSF Inline coupling insert w/Shut-off	22.52
QD-HFCD191235GHT	3/8"	3/4" FGHT PSF Inline coupling insert w/Shut-off	24.97
QD-HFC101235GHT	3/8"	3/8" MNPT PSF Coupler body Straight-thru	24.67
QD-HFC191235GHT	3/8"	1/2" MNPT PSF Coupler body Straight-thru	22.94



HIGH FLOW COUPLINGS BODIES POLYPROPYLENE (gray)

PART NUMBER	FLOW	PRODUCT DESCRIPTION	PRICE \$
QD-HFCD10612	3/8"	3/8" MNPT PP Coupler body w/Shut-off	17.95
QD-HFCD10812	3/8"	1/2" MNPT PP Coupler body w/Shut-off	18.58
QD-HFC10612	3/8"	3/8" MNPT PSF Coupler body Straight-thru	16.95
QD-HFC10812	3/8"	1/2" MNPT PSF Coupler body Straight-thru	15.79



HIGH FLOW COUPLINGS BODIES POLYSULFONE (white)

PART NUMBER	FLOW	PRODUCT DESCRIPTION	PRICE \$
QD-HFCD10635	3/8"	3/8" MNPT PSF Coupler body w/Shut-off	24.93
QD-HFCD10835	3/8"	1/2" MNPT PSF Coupler body w/Shut-off	24.81
QD-HFC10635	3/8"	3/8" MNPT PSF Coupler body Straight-thru	19.75
QD-HFC10835	3/8"	1/2" MNPT PSF Coupler body Straight-thru	19.81



MEDICAL SOLUTIONS INTERNATIONAL
 5646 MERRIAM DRIVE
 MERRIAM, KS 66203
www.medicalsolutionskc.com

800.326.5275
 913.438.9700
 FAX 913.438.9701

IN-LINE HOSE BARB BODY POLYPROPYLENE (gray)

PART NUMBER	FLOW	PRODUCT DESCRIPTION	PRICE \$
QD-HFCD17612	3/8"	3/8" ID PP Barbed Inline body w/Shut-off	19.83
QD-HFCD17812	3/8"	1/2" ID PP Barbed Inline body w/Shut-off	19.83
QD-HFCD171212	3/8"	3/4" ID PP Barbed Inline body w/Shut-off	19.99
QD-HFC17612	3/8"	3/8" ID PP Barbed inline body Straight-thru	16.26
QD-HFC17812	3/8"	1/2" ID PP Barbed inline body Straight-thru	16.63
QD-HFC171212	3/8"	3/4" ID PP Barbed inline body Straight-thru	16.52



IN-LINE HOSE BARB BODY POLYSULFONE (white)

PART NUMBER	FLOW	PRODUCT DESCRIPTION	PRICE \$
QD-HFCD17635	3/8"	3/8" ID PSF Barbed Inline body w/Shut-off	24.42
QD-HFCD17835	3/8"	1/2" ID PSF Barbed Inline body w/Shut-off	24.34
QD-HFCD171235	3/8"	3/4" ID PSF Barbed Inline body w/Shut-off	25.23



PANEL MOUNT HOSE BARB BODY POLYPROPYLENE (gray)

PART NUMBER	FLOW	PRODUCT DESCRIPTION	PRICE \$
QD-HFCD16612NA	3/8"	3/8" ID PP Panel mount body w/Shut-off	25.87
QD-HFCD16812NA	3/8"	1/2" ID PP Panel mount body w/Shut-off	23.54
QD-HFCD161212NA	3/8"	3/4" ID PP Panel mount body w/Shut-off	23.97
QD-HFC16612NA	3/8"	3/8" ID PP Panel mount body Straight-thru	32.25
QD-HFC16812NA	3/8"	1/2" ID PP Panel mount body Straight-thru	21.24
QD-HFC161212NA	3/8"	3/4" ID PP Panel mount body Straight-thru	20.98



PANEL MOUNT HOSE BARB BODY POLYSULFONE (white)

PART NUMBER	FLOW	PRODUCT DESCRIPTION	PRICE \$
QD-HFCD16635NA	3/8"	3/8" ID PSF Panel mount body w/Shut-off	30.76
QD-HFCD16835NA	3/8"	1/2" ID PSF Panel mount body w/Shut-off	29.64
QD-HFCD161235NA	3/8"	3/4" ID PSF Panel mount body w/Shut-off	29.82
QD-HFC16635NA	3/8"	3/8" ID PSF Panel mount body Straight-thru	31.76
QD-HFC16835NA	3/8"	1/2" ID PSF Panel mount body Straight-thru	31.88
QD-HFC161235NA	3/8"	3/4" ID PSF Panel mount body Straight-thru	32.69



MEDICAL SOLUTIONS INTERNATIONAL
 5646 MERRIAM DRIVE
 MERRIAM, KS 66203
www.medicalsolutionskc.com

800.326.5275
 913.438.9700
 FAX 913.438.9701

HIGH FLOW COUPLING INSERTS

GARDEN HOSE THREAD INSERT POLYSULPHONE (white)

PART NUMBER	FLOW	PRODUCT DESCRIPTION	PRICE \$
QD-HFCD261235GHT	3/8"	3/4" FGHT PSF Inline coupling insert w/Shut-off	21.77
QD-HFC241235GHT	3/8"	3/4" MGHT PSF Inline coupling insert Straight-thru	13.43
QD-HFC261235GHT	3/8"	3/4" FGHT PSF Inline coupling insert Straight-thru	15.64
QD-HFCD241235GHT	3/8"	3/4" MGHT PSF Inline coupling insert w/Shut-off	20.77



PIPE THREAD INSERT POLYPROPYLENE (gray)

PART NUMBER	FLOW	PRODUCT DESCRIPTION	PRICE \$
QD-HFCD24612	3/8"	3/8" MNPT PP Inline coupling insert w/Shut-off	15.56
QD-HFCD24812	3/8"	1/2" MNPT PP Inline coupling insert w/Shut-off	15.78
QD-HFC24612	3/8"	3/8" MNPT PP Inline coupling insert Straight-thru	7.79
QD-HFC24812	3/8"	1/2" MNPT PP Inline coupling insert Straight-thru	7.79



PIPE THREAD INSERT POLYSULFONE (white)

PART NUMBER	FLOW	PRODUCT DESCRIPTION	PRICE \$
QD-HFCD24635	3/8"	3/8" MNPT PSF Inline coupling insert w/Shut-off	17.99
QD-HFCD24835	3/8"	1/2" MNPT PSF Inline coupling insert w/Shut-off	17.45
QD-HFC24635	3/8"	3/8" MNPT PSF Inline coupling insert Straight-thru	11.25
QD-HFC24835	3/8"	1/2" MNPT PSF Inline coupling insert Straight-thru	11.37



MEDICAL SOLUTIONS INTERNATIONAL
 5646 MERRIAM DRIVE
 MERRIAM, KS 66203
www.medicalsolutionskc.com

800.326.5275
 913.438.9700
 FAX 913.438.9701

HIGH FLOW COUPLING INSERTS

HOSE BARB INSERT POLYPROPYLENE (gray)

PART NUMBER	FLOW	PRODUCT DESCRIPTION	PRICE \$
QD-HFCD22612	3/8"	3/8" ID PP Barbed coupling insert w/Shut-off	15.29
QD-HFCD22812	3/8"	1/2" ID PP Barbed coupling insert w/Shut-off	15.44
QD-HFCD221212	3/8"	3/4" ID PP Barbed coupling insert w/Shut-off	15.75
QD-HFC22612	3/8"	3/8" ID PP Barbed coupling insert Straight-thru	7.46
QD-HFC22812	3/8"	1/2" ID PP Barbed coupling insert Straight-thru	7.41
QD-HFC221212	3/8"	3/4" ID PP Barbed coupling insert Straight-thru	8.77



HOSE BARB INSERT POLYSULPHONE (white)

PART NUMBER	FLOW	PRODUCT DESCRIPTION	PRICE \$
QD-HFCD22635	3/8"	3/8" ID PSF Barbed coupling insert w/Shut-off	17.36
QD-HFCD22835	3/8"	1/2" ID PSF Barbed coupling insert w/Shut-off	17.87
QD-HFCD221235	3/8"	3/4" ID PSF Barbed coupling insert w/Shut-off	18.96
QD-HFC22635	3/8"	3/8" ID PSF Barbed coupling insert Straight-thru	10.52
QD-HFC22835	3/8"	1/2" ID PSF Barbed coupling insert Straight-thru	11.41
QD-HFC221235	3/8"	3/4" ID PSF Barbed coupling insert Straight-thru	11.83



ELBOW HOSE BARB INSERT POLYPROPYLENE (gray)

PART NUMBER	FLOW	PRODUCT DESCRIPTION	PRICE \$
QD-HFCD23612	3/8"	3/8" ID PP Barbed coupling insert w/Shut-off	17.47
QD-HFCD23812	3/8"	1/2" ID PP Barbed coupling insert w/Shut-off	17.98
QD-HFC23612	3/8"	3/8" ID PP Barbed elbow insert Straight-thru	11.52
QD-HFC23812	3/8"	1/2" ID PP Barbed elbow insert Straight-thru	11.51



ELBOW HOSE BARB INSERT POLYSULPHONE (white)

PART NUMBER	FLOW	PRODUCT DESCRIPTION	PRICE \$
QD-HFCD23635	3/8"	3/8" ID PSF Barbed coupling insert w/Shut-off	19.63
QD-HFCD23835	3/8"	1/2" ID PSF Barbed coupling insert w/Shut-off	19.66
QD-HFC23635	3/8"	3/8" ID PSF Barbed elbow insert Straight-thru	11.92
QD-HFC23835	3/8"	1/2" ID PSF Barbed elbow insert Straight-thru	11.78



MEDICAL SOLUTIONS INTERNATIONAL
 5646 MERRIAM DRIVE
 MERRIAM, KS 66203
www.medicalsolutionskc.com

800.326.5275
 913.438.9700
 FAX 913.438.9701

QUICK DISCONNECT FITTINGS

52

LOW FLOW COUPLING INSERTS

MALE PIPE THREAD ACETAL (white)

PART NUMBER	FLOW	PRODUCT DESCRIPTION	PRICE \$
QD-PMC1002	1/8"	1/8" MT Pipe thread body Straight-thru	7.55
QD-PMC1004	1/8"	1/4" MT Pipe thread body Straight-thru	7.55
QD-PLC10004	1/4"	1/4" MT Pipe thread body Straight-thru	8.91
QD-PLC10006	1/4"	3/8" MT Pipe thread body Straight-thru	8.91
QD-PMCD1002	1/8"	1/8" MT Pipe thread body w/Shut-off	9.51
QD-PMCD1004	1/8"	1/4" MT Pipe thread body w/Shut-off	10.36
QD-PLCD10006	1/4"	3/8" MT Pipe thread body w/Shut-off	10.88



MALE PIPE THREAD POLYPRO (beige)

PART NUMBER	FLOW	PRODUCT DESCRIPTION	PRICE \$
QD-PMC100212	1/8"	1/8" MT PP Pipe thread body Straight-thru	9.68
QD-PMC100412	1/8"	1/4" MT PP Pipe thread body Straight-thru	9.79
QD-PLC1000412	1/4"	1/4" MT PP Pipe thread body Straight-thru	10.92
QD-PLC000612	1/4"	3/8" MT PP Pipe thread body Straight-thru	10.98
QD-PMCD100212	1/8"	1/8" MT PP Pipe thread body w/Shut-off	10.98
QD-PMCD100412	1/8"	1/4" MT PP Pipe thread body w/Shut-off	11.93
QD-PLCD1000412	1/4"	3/8" MT PP Pipe thread body w/Shut-off	13.64
QD-PLCD1000612	1/4"	3/8" MT PP Pipe thread body w/Shut-off	13.96



MEDICAL SOLUTIONS INTERNATIONAL
5646 MERRIAM DRIVE
MERRIAM, KS 66203
www.medicalsolutionskc.com

800.326.5275
913.438.9700
FAX 913.438.9701

LOW FLOW COUPLING INSERTS

IN-LINE HOSE BARB ACETAL (white)			
PART NUMBER	FLOW	PRODUCT DESCRIPTION	PRICE \$
QD-PMC1701	1/8"	1/16" Barb inline body Straight-thru	7.85
QD-PMC1702	1/8"	1/8" Barb inline body Straight-thru	5.66
QD-PMC1704	1/8"	1/4" Barb inline body Straight-thru	6.13
QD-PLC17004	1/4"	1/4" Barb inline body Straight-thru	7.31
QD-PLC17006	1/4"	3/8" Barb inline body Straight-thru	9.99
QD-PMCD1701	1/8"	1/16" Barb inline body w/Shut-off	11.36
QD-PMCD1702	1/8"	1/8" Barb inline body w/Shut-off	9.64
QD-PMCD1704	1/8"	1/4" Barb inline body w/Shut-off	10.51
QD-PLCD17004	1/4"	1/4" Barb inline body w/Shut-off	9.78
QD-PLCD17006	1/4"	3/8" Barb inline body w/Shut-off	10.66



IN-LINE HOSE BARB POLYPRO (beige)			
PART NUMBER	FLOW	PRODUCT DESCRIPTION	PRICE \$
QD-PMC170212	1/8"	1/16" PP Barb inline body Straight-thru	10.98
QD-PMC170412	1/8"	1/4" PP Barb inline body Straight-thru	11.98
QD-PLC1700412	1/4"	1/4" PP Barb inline body Straight-thru	14.12
QD-PLC1700612	1/4"	3/8" PP Barb inline body Straight-thru	14.77
QD-PMCD170112	1/8"	1/16" PP Barb inline body w/Shut-off	18.17
QD-PMCD170212	1/8"	1/8" PP Barb inline body w/Shut-off	14.96
QD-PMCD170412	1/8"	1/4" PP Barb inline body w/Shut-off	17.11
QD-PLCD1700612	1/4"	3/8" PP Barb inline body w/Shut-off	16.90



MEDICAL SOLUTIONS INTERNATIONAL
 5646 MERRIAM DRIVE
 MERRIAM, KS 66203
www.medicalsolutionskc.com

800.326.5275
 913.438.9700
 FAX 913.438.9701

QUICK DISCONNECT FITTINGS

54

LOW FLOW COUPLING INSERTS

PANEL-MOUNT HOSE BARB ACETAL (white)

PART NUMBER	FLOW	PRODUCT DESCRIPTION	PRICE \$
QD-PMC1601NA	1/8"	1/16" Barb panel mount body Straight-thru	13.11
QD-PMC1602NA	1/8"	1/8" Barb panel mount body Straight-thru	11.96
QD-PMC1604NA	1/8"	1/4" Barb panel mount body Straight-thru	12.16
QD-PLC16004NA	1/4"	1/4" Barb panel mount body Straight-thru	16.85
QD-PMCD1601NA	1/8"	1/16" Barb panel mount body w/Shut-off	14.71
QD-PMCD1602NA	1/8"	1/8" Barb panel mount body w/Shut-off	13.57
QD-PMCD1604NA	1/8"	1/4" Barb panel mount body w/Shut-off	15.77
QD-PLCD16004NA	1/4"	1/4" Barb panel mount body w/Shut-off	18.96
QD-PLCD16006NA	1/4"	3/8" Barb panel mount body w/Shut-off	18.96



PANEL-MOUNT HOSE BARB POLYPRO (beige)

PART NUMBER	FLOW	PRODUCT DESCRIPTION	PRICE \$
QD-PMC160112NA	1/8"	1/16" PP Barb panel mount body Straight-thru	16.58
QD-PMC160212NA	1/8"	1/8" PP Barb panel mount body Straight-thru	15.73
QD-PMC16042NA	1/8"	1/4" PP Barb panel mount body Straight-thru	15.77
QD-PLC160012NA	1/4"	1/4" PP Barb panel mount body Straight-thru	19.61
QD-PLC1600612NA	1/4"	3/8" PP Barb panel mount body Straight-thru	19.62
QD-PMCD160112NA	1/8"	1/16" PP Barb panel mount body w/Shut-off	17.63
QD-PMCD160212NA	1/8"	1/8" PP Barb panel mount body w/Shut-off	13.98
QD-PMCD160412NA	1/8"	1/4" PP Barb panel mount body w/Shut-off	18.52
QD-PLCD1600412NA	1/4"	1/4" PP Barb panel mount body w/Shut-off	24.22
QD-PLCD1600612NA	1/4"	3/8" PP Barb panel mount body w/Shut-off	22.17



MEDICAL SOLUTIONS INTERNATIONAL
5646 MERRIAM DRIVE
MERRIAM, KS 66203
www.medicalsolutionskc.com

800.326.5275
913.438.9700
FAX 913.438.9701

LOW FLOW COUPLING INSERTS

IN-LINE FERRULESS COMPRESSION FITTING ACETAL (white)			
PART NUMBER	FLOW	PRODUCT DESCRIPTION	PRICE \$
QD-PMC1304NA	1/8"	1/4" OD Inline body Straight-thru	10.11
QD-PLC13006NA	1/4"	3/8" OD Inline body Straight-thru	12.92
QD-PMCD1304NA	1/8"	1/4" OD Inline body w/Shut-off	11.74
QD-PLCD13006NA	1/4"	3/8" OD Inline body w/Shut-off	13.99



IN-LINE FERRULESS COMPRESSION FITTING POLYPRO (beige)			
PART NUMBER	FLOW	PRODUCT DESCRIPTION	PRICE \$
QD-PMC130412NA	1/8"	1/4" OD PP Inline body Straight-thru	15.74
QD-PLC1300612NA	1/4"	3/8" OD PP Inline body Straight-thru	13.24
QD-PMCD130412NA	1/8"	1/4" OD PP Inline body w/Shut-off	16.91
QD-PLCD1300612NA	1/4"	3/8" OD PP Inline body w/Shut-off	24.91

PANEL-MOUNT FERRULESS COMPRESSION FITTING ACETAL (white)			
PART NUMBER	FLOW	PRODUCT DESCRIPTION	PRICE \$
QD-PMC1204NA	1/8"	1/4" OD Panel mount body Straight-thru	12.49
QD-PLC12006NA	1/4"	3/8" OD Panel mount body Straight-thru	17.77
QD-PMCD1204NA	1/8"	1/4" OD Panel mount body w/Shut-off	14.24
QD-PLCD12006NA	1/4"	3/8" OD Panel mount body w/Shut-off	21.41



PANEL-MOUNT FERRULESS COMPRESSION FITTING POLYPRO (beige)			
PART NUMBER	FLOW	PRODUCT DESCRIPTION	PRICE \$
QD-PMC120412NA	1/8"	1/4" OD PP Panel mount body Straight-thru	18.49
QD-PLC1200612NA	1/4"	3/8" OD PP Panel mount body Straight-thru	20.96
QD-PMCD120412NA	1/8"	1/4" OD PP Panel mount body w/Shut-off	19.49
QD-PLCD1200612NA	1/4"	3/8" OD PP Panel mount body w/Shut-off	26.23

MEDICAL SOLUTIONS INTERNATIONAL
 5646 MERRIAM DRIVE
 MERRIAM, KS 66203
www.medicalsolutionskc.com

800.326.5275
 913.438.9700
 FAX 913.438.9701

LOW FLOW COUPLING INSERTS

STRAIGHT HOSE BARB ACETAL (white)

PART NUMBER	FLOW	PRODUCT DESCRIPTION	PRICE \$
QD-PMC2201	1/8"	1/16" Barb CPLG INS Straight-thru	2.94
QD-PMC2202	1/8"	1/8" Barb CPLG INS Straight-thru	2.47
QD-PMC2204	1/8"	1/4" Barb CPLG INS Straight-thru	2.81
QD-PMC22004	1/8"	1/4" Barb CPLG INS Straight-thru	2.66
QD-PLC22006	1/4"	3/8" Barb CPLG INS Straight-thru	2.66
QD-PMCD2201	1/8"	1/16" Barb CPLG INS w/Shut-off	10.28
QD-PMCD2202	1/8"	1/8" Barb CPLG INS w/Shut-off	9.26
QD-PMCD2204	1/8"	1/8" Barb CPLG INS w/Shut-off	9.26
QD-PMCD22004	1/8"	1/4" Barb CPLG INS w/Shut-off	9.48
QD-PMCD22006	1/8"	3/8" Barb CPLG INS w/Shut-off	9.48



STRAIGHT HOSE BARB POLYPRO (beige)

PART NUMBER	FLOW	PRODUCT DESCRIPTION	PRICE \$
QD-PMC220112	1/8"	1/16" Barb valve hose Straight-thru	5.47
QD-PMC220212	1/8"	1/8" Barb valve hose Straight-thru	3.95
QD-PMC220412	1/8"	1/4" Barb valve hose Straight-thru	4.21
QD-PLC2200412	1/4"	1/4" Barb valve hose Straight-thru	4.21
QD-PLC2200612	1/4"	3/8" Barb valve hose Straight-thru	4.21
QD-PMCD220112	1/8"	1/16" Barb valve hose w/Shut-off	19.92
QD-PMCD220212	1/8"	1/8" Barb valve hose w/Shut-off	11.91
QD-PMCD220412	1/8"	1/4" Barb valve hose w/Shut-off	13.39
QD-PLCD2200412	1/4"	1/4" Barb valve hose w/Shut-off	12.98
QD-PLCD2200612	1/4"	3/8" Barb valve hose w/Shut-off	13.41

MEDICAL SOLUTIONS INTERNATIONAL
 5646 MERRIAM DRIVE
 MERRIAM, KS 66203
www.medicalsolutionskc.com

800.326.5275
 913.438.9700
 FAX 913.438.9701

LOW FLOW COUPLING INSERTS

STRAIGHT FERRULESS COMPRESSION FITTING ACETAL (white)

PART NUMBER	FLOW	PRODUCT DESCRIPTION	PRICE \$
QD-PMC2004NA	1/8"	1/4" OD Compression Straight-thru	5.96
QD-PMC2006NA	1/8"	3/8" OD Compression Straight-thru	6.88
QD-PLC20006NA	1/4"	3/8" OD Compression Straight-thru	5.93
QD-PMCD2004NA	1/8"	1/4" OD Compression w/Shut-off	10.43
QD-PMCD2006NA	1/8"	3/8" OD Compression w/Shut-off	11.78
QD-PLCD20006NA	1/4"	3/8" OD Compression w/Shut-off	12.45



STRAIGHT FERRULESS COMPRESSION FITTING POLYPRO (beige)

PART NUMBER	FLOW	PRODUCT DESCRIPTION	PRICE \$
QD-PMC200412NA	1/8"	1/4" OD PP Compression Straight-thru	6.71
QD-PLC2000612NA	1/4"	3/8" OD PP Compression Straight-thru	7.98
QD-PMCD200412NA	1/8"	1/4" OD PP Compression w/Shut-off	14.82
QD-PLCD2000612NA	1/4"	3/8" OD PP Compression w/Shut-off	18.19



PANEL MOUNT FERRULESS COMPRESSION FITTING

PART NUMBER	FLOW	PRODUCT DESCRIPTION	PRICE \$
QD-PMC4004NA	1/8"	1/4" OD Panel mount compression Straight-thru	10.41
QD-PLC40004NA	1/4"	1/4" OD Panel mount compression Straight-thru	9.46
QD-PLC40006NA	1/4"	3/8" OD Panel mount compression Straight-thru	10.31
QD-PMCD4004NA	1/8"	1/4" OD Panel mount compression w/Shut-off	15.73
QD-PLCD40004NA	1/4"	1/4" OD Panel mount compression w/Shut-off	12.76
QD-PLCD40006NA	1/4"	3/8" OD Panel mount compression w/Shut-off	15.91



MEDICAL SOLUTIONS INTERNATIONAL
 5646 MERRIAM DRIVE
 MERRIAM, KS 66203
www.medicalsolutionskc.com

800.326.5275
 913.438.9700
 FAX 913.438.9701

LOW FLOW COUPLING INSERTS

ELBOW HOSE BARB ACETAL (white)			
PART NUMBER	FLOW	PRODUCT DESCRIPTION	PRICE \$
QD-PMC2302	1/8"	1/8" ID Barbed elbow Straight-thru	4.47
QD-PMC2304	1/8"	1/4" ID Barbed elbow Straight-thru	4.82
QD-PLC23004	1/4"	1/4" ID Barbed elbow Straight-thru	5.98
QD-PLC23006	1/4"	3/8" ID Barbed elbow Straight-thru	6.48
QD-PMCD2302	1/8"	1/8" ID Barbed elbow w/Shut-off	12.63
QD-PMCD2304	1/8"	1/4" ID Barbed elbow w/Shut-off	12.63
QD-PLCD23004	1/4"	1/4" ID Barbed elbow w/Shut-off	12.23
QD-PLCD23006	1/4"	3/8" ID Barbed elbow w/Shut-off	12.23



ELBOW HOSE BARB POLYPRO (beige)			
PART NUMBER	FLOW	PRODUCT DESCRIPTION	PRICE \$
QD-PMC230212	1/8"	1/8" ID PP Barbed elbow Straight-thru	8.57
QD-PMC230412	1/8"	1/4" ID PP Barbed elbow Straight-thru	8.57
QD-PLC2300412	1/4"	1/4" ID PP Barbed elbow Straight-thru	9.96
QD-PLC2300612	1/4"	3/8" ID PP Barbed elbow Straight-thru	9.96
QD-PMCD230212	1/8"	1/8" ID PP Barbed elbow w/Shut-off	15.81
QD-PMCD230412	1/8"	1/4" ID PP Barbed elbow w/Shut-off	15.81
QD-PLCD2300412	1/4"	1/4" ID PP Barbed elbow w/Shut-off	14.85
QD-PLCD2300612	1/4"	3/8" ID PP Barbed elbow w/Shut-off	15.52



PANEL MOUNT HOSE BARB			
PART NUMBER	FLOW	PRODUCT DESCRIPTION	PRICE \$
QD-PMC4202NA	1/8"	1/8" ID Barb panel-mount Straight-thru	7.83
QD-PMC4204NA	1/8"	1/4" ID Barb panel-mount Straight-thru	7.96
QD-PLC42004NA	1/4"	1/4" ID Barb panel-mount Straight-thru	6.93
QD-PLCD42004NA	1/4"	1/4" ID Barb panel-mount w/Shut-off	16.36
QD-PLC42006NA	1/4"	3/8" ID Barb panel-mount Straight-thru	7.67



MEDICAL SOLUTIONS INTERNATIONAL
 5646 MERRIAM DRIVE
 MERRIAM, KS 66203
www.medicalsolutionskc.com

800.326.5275
 913.438.9700
 FAX 913.438.9701

LOW FLOW COUPLING INSERTS

ELBOW FERRULESS COMPRESSION FITTING ACETAL (white)

PART NUMBER	FLOW	PRODUCT DESCRIPTION	PRICE \$
QD-PMC2104NA	1/8"	1/4" OD Elbow Straight-thru	5.69
QD-PMC2106NA	1/8"	3/8" OD Elbow Straight-thru	5.66
QD-PMCD2104NA	1/8"	1/4" OD Elbow w/Shut-off	13.67
QD-PLCD21006NA	1/4"	3/8" OD Elbow w/Shut-off	13.47



ELBOW FERRULESS COMPRESSION FITTING POLYPRO (beige)

PART NUMBER	FLOW	PRODUCT DESCRIPTION	PRICE \$
QD-PLC2100612NA	1/4"	3/8" OD PP Elbow Straight-thru	10.23
QD-PMCD210412NA	1/8"	1/4" OD PP Elbow w/Shut-off	18.93
QD-PLCD2100612NA	1/4"	3/8" OD PP Elbow w/Shut-off	18.63

PIPE THREAD ACETAL (white)

PART NUMBER	FLOW	PRODUCT DESCRIPTION	PRICE \$
QD-PMC2402	1/8"	1/8" Male pipe thread Straight-thru	3.69
QD-PMC2404	1/8"	1/4" Male pipe thread Straight-thru	3.69
QD-PLC24004	1/4"	1/4" Male pipe thread Straight-thru	3.62
QD-PLC24006	1/4"	3/8" Male pipe thread Straight-thru	3.99
QD-PMCD2402	1/8"	1/8" Male pipe thread w/Shut-off	9.76
QD-PMCD2404	1/8"	1/4" Male pipe thread w/Shut-off	10.28



PIPE THREAD POLYPRO (beige)

PART NUMBER	FLOW	PRODUCT DESCRIPTION	PRICE \$
QD-PMC240212	1/8"	1/8" PP Male pipe thread Straight-thru	5.63
QD-PLC2400412	1/4"	1/8" PP Male pipe thread Straight-thru	8.35
QD-PMCD240212	1/8"	1/8" PP Male pipe thread w/Shut-off	11.93
QD-PLCD2400412	1/4"	1/4" PP Male pipe thread w/Shut-off	13.96



MEDICAL SOLUTIONS INTERNATIONAL
 5646 MERRIAM DRIVE
 MERRIAM, KS 66203
www.medicalsolutionskc.com

800.326.5275
 913.438.9700
 FAX 913.438.9701

PARKER MALE CONNECTOR

PART NUMBER	PRODUCT DESCRIPTION	PRICE \$
P4MC2	1/4" Tube Compression X 1/8" Male NPT	2.57
P4MC4	1/4" Tube Compression X 1/4" Male NPT	2.92
P5MC2	5/16" Tube Compression X 1/8" Male NPT	5.43
P5MC4	5/16" Tube Compression X 1/4" Male NPT	3.09
P6MC2	3/8" Tube Compression X 1/8" Male NPT	3.29
P6MC4	3/8" Tube Compression X 1/4" Male NPT	3.55
P6MC6	3/8" Tube Compression X 3/8" Male NPT	3.71
P6MC8	3/8" Tube Compression X 1/2" Male NPT	3.95
P6MC12	3/8" Tube Compression X 1/8" Male NPT	3.97
P8MC2	1/2" Tube Compression X 1/4" Male NPT	5.97
P8MC4	1/2" Tube Compression X 1/4" Male NPT	4.26
P8MC6	1/2" Tube Compression X 3/8" Male NPT	4.96
P8MC8	1/2" Tube Compression X 1/2" Male NPT	4.98
P8MC12	1/2" Tube Compression X 3/4" Male NPT	5.97
P10MC2	5/8" Tube Compression X 1/8" Male NPT	5.49
P10MC4	5/8" Tube Compression X 1/4" Male NPT	5.73
P10MC6	5/8" Tube Compression X 3/8" Male NPT	5.73
P10MC8	5/8" Tube Compression X 1/2" Male NPT	6.53
P10MC12	5/8" Tube Compression X 3/4" Male NPT	6.88



PARKER FEMALE CONNECTOR

PART NUMBER	PRODUCT DESCRIPTION	PRICE \$
P4FC2	1/4" Tube Compression X 1/8" Female NPT	5.27
P4FC4	1/4" Tube Compression X 1/4" Female NPT	4.79
P6FC4	3/8" Tube Compression X 1/4" Female NPT	4.52
P6FC6	3/8" Tube Compression X 3/8" Female NPT	6.92
P6FC8	3/8" Tube Compression X 1/2" Female NPT	6.92
P8FC6	1/2" Tube Compression X 3/8" Female NPT	8.89
P8FC8	1/2" Tube Compression X 1/2" Female NPT	8.29
P10FC8	5/8" Tube Compression X 1/2" Female NPT	5.88



MEDICAL SOLUTIONS INTERNATIONAL
 5646 MERRIAM DRIVE
 MERRIAM, KS 66203
www.medicalsolutionskc.com

800.326.5275
 913.438.9700
 FAX 913.438.9701

PARKER MALE BRANCH TEE

PART NUMBER	PRODUCT DESCRIPTION	PRICE \$
P4MT2	1/4" Tube Compression X 1/8" Male NPT	5.87
P4MT4	1/4" Tube Compression X 1/4" Male NPT	6.56
P5MT2	5/16" Tube Compression X 1/8" Male NPT	8.15
P5MT4	5/16" Tube Compression X 1/4" Male NPT	16.32
P6MT4	3/8" Tube Compression X 1/4" Male NPT	6.53
P6MT6	3/8" Tube Compression X 3/8" Male NPT	7.95
P8MT6	1/2" Tube Compression X 3/8" Male NPT	11.24
P8MT8	1/2" Tube Compression X 1/2" Male NPT	12.99
P10MT8	5/8" Tube Compression X 1/2" Male NPT	8.65



PARKER MALE ELBOW

PART NUMBER	PRODUCT DESCRIPTION	PRICE \$
P4ME2	1/4" Tube Compression X 1/8" Male NPT	3.33
P4ME4	1/4" Tube Compression X 1/4" Male NPT	3.81
P4ME6	1/4" Tube Compression X 3/8" Male NPT	4.55
P5ME2	5/16" Tube Compression X 1/8" Male NPT	4.73
P5ME4	5/16" Tube Compression X 1/4" Male NPT	5.43
P5ME6	5/16" Tube Compression X 3/8" Male NPT	6.57
P6ME4	3/8" Tube Compression X 1/4" Male NPT	4.93
P6ME6	3/8" Tube Compression X 3/8" Male NPT	4.99
P6ME8	3/8" Tube Compression X 1/2" Male NPT	5.29
P8ME12	3/8" Tube Compression X 3/4" Male NPT	7.88
P8ME8	1/2" Tube Compression X 1/2" Male NPT	6.93
P10ME8	5/8" Tube Compression X 1/2" Male NPT	6.35



PARKER FEMALE ELBOW

PART NUMBER	PRODUCT DESCRIPTION	PRICE \$
P4FE2	1/4" Tube Compression X 1/8" Female NPT	5.43
P4FE4	1/4" Tube Compression X 1/4" Female NPT	5.43
P5FE2	1/4" Tube Compression X 5/16" Female NPT	6.36
P6FE4	3/8" Tube Compression X 1/4" Female NPT	6.92
P6FE6	3/8" Tube Compression X 3/8" Female NPT	6.92
P8FE6	1/2" Tube Compression X 3/8" Female NPT	6.92
P8FE8	1/2" Tube Compression X 1/2" Female NPT	6.92
P10FE8	5/8" Tube Compression X 5/8" Female NPT	6.92



MEDICAL SOLUTIONS INTERNATIONAL
 5646 MERRIAM DRIVE
 MERRIAM, KS 66203
www.medicalsolutionskc.com

800.326.5275
 913.438.9700
 FAX 913.438.9701

PARKER TEE UNION

PART NUMBER	PRODUCT DESCRIPTION	PRICE \$
P4TU4	1/4" X 1/4" Tube Compression Tee	7.61
P5TU5	5/16" X 5/16" Tube Compression Tee	14.98
P6TU6	3/8" X 3/8" Tube Compression Tee	8.82
P6TU10	3/8" X 5/8" Tube Compression Tee	18.82
P8TU6	1/2" X 3/8" Tube Compression Tee	10.76
P8TU8	1/2" X 1/2" Tube Compression Tee	13.17
P10TU6	5/8" X 3/8" Tube Compression Tee	12.14
P10TU10	5/8" X 5/8" Tube Compression Tee	14.95



PARKER UNION CONNECTOR

PART NUMBER	PRODUCT DESCRIPTION	PRICE \$
P4UC4	1/4" X 1/4" Tube Compression Union	3.92
P5UC4	5/16" X 1/4" Tube Compression Union	4.98
P5UC5	5/16" X 5/16" Tube Compression Union	5.37
P6UC4	3/8" X 1/4" Tube Compression Union	5.29
P6UC5	3/8" X 5/16" Tube Compression Union	5.94
P6UC6	3/8" X 3/8" Tube Compression Union	5.84
P8UC6	1/2" X 3/8" Tube Compression Union	6.23
P8UC8	1/2" X 1/2" Tube Compression Union	6.79
P10UC6	5/8" X 3/8" Tube Compression Union	6.45
P10UC8	5/8" X 1/2" Tube Compression Union	6.77
P10UC10	5/8" X 5/8" Tube Compression Union	8.42



PARKER ELBOW UNION

PART NUMBER	PRODUCT DESCRIPTION	PRICE \$
P4EU4	1/4" X 1/4" Tube Comp Elbow Union	5.89
P5EU4	5/16" X 1/4" Tube Comp Elbow Union	8.35
P5EU5	5/16" X 5/16" Tube Comp Elbow Union	6.08
P6EU4	3/8" X 1/4" Tube Comp Elbow Union	7.61
P6EU5	3/8" X 5/16" Tube Comp Elbow Union	6.77
P6EU6	3/8" X 3/8" Tube Comp Elbow Union	7.87
P8EU6	1/2" X 3/8" Tube Comp Elbow Union	7.83
P8EU8	1/2" X 1/2" Tube Comp Elbow Union	8.71
P10EU10	5/8" X 5/8" Tube Comp Elbow Union	9.71



MEDICAL SOLUTIONS INTERNATIONAL
 5646 MERRIAM DRIVE
 MERRIAM, KS 66203
www.medicalsolutionskc.com

800.326.5275
 913.438.9700
 FAX 913.438.9701

MUR-LOK COMPRESSION TEE

PART NUMBER	PRODUCT DESCRIPTION	PRICE \$
ML-A0630405	3/8" Compression X 1/4" Female NPT	19.75
ML-A0630425	3/8" Compression X 1/4" ML	19.75
ML-A0630625	3/8" Compression X 3/8" ML	19.75
ML-A0630825	3/8" Compression X 1/2" ML	19.75
ML-A0830405	1/2" Compression X 1/4" Female NPT	19.75
ML-A0830425	1/2" Compression X 1/4" ML	19.75
ML-A0830625	1/2" Compression X 3/8" ML	19.75
ML-A0830825	1/2" Compression X 1/2" ML	19.75
ML-A1030405	5/8" Compression X 1/4" Female NPT	19.75
ML-A1030425	5/8" Compression X 1/4" ML	19.75
ML-A1030625	5/8" Compression X 3/8" ML	19.75
ML-A1030825	5/8" Compression X 1/2" ML	19.75



MUR-LOK IN-LINE BALL VALVES

PART NUMBER	PRODUCT DESCRIPTION	PRICE \$
ML-G0400405	1/4" Female NPT X 1/4" Female NPT	14.25
ML-G0400415	1/4" Female NPT X 1/4" Male NPT	14.25
ML-G0420405	1/4" ML X 1/4" Female NPT	14.25
ML-G0420415	1/4" ML X 1/4" Male NPT	14.25
ML-G0420425	1/4" ML X 1/4" ML	14.25
ML-G0420625	1/4" ML X 3/8" ML	14.25
ML-G0420825	1/4" ML X 1/2" ML	14.25
ML-G0600605	3/8" Female NPT X 3/8" Female NPT	14.25
ML-G0600615	3/8" Female NPT X 3/8" Male NPT	14.25
ML-G0620405	3/8" ML X 1/4" Male NPT	14.25
ML-G0620415	3/8" ML X 1/4" Male NPT	14.25
ML-G0620615	3/8" ML X 3/8" Male NPT	14.25
ML-G0620625	3/8" ML X 3/8" ML	14.25
ML-G0620825	3/8" ML X 1/2" ML	14.25
ML-G0820615	1/2" ML X 3/8" Male NPT	14.25
ML-G0820825	1/2" ML X 1/2" ML	14.25



MEDICAL SOLUTIONS INTERNATIONAL
 5646 MERRIAM DRIVE
 MERRIAM, KS 66203
www.medicalsolutionskc.com

800.326.5275
 913.438.9700
 FAX 913.438.9701

MURLOK MALE NPTF CONNECTORS

PART NUMBER	PRODUCT DESCRIPTION	PRICE \$
ML-O0420216	1/4" ML X 1/8" Male NPT	1.93
ML-O0420416	1/4" ML X 1/4" Male NPT	1.96
ML-O0420616	1/4" ML X 3/8" Male NPT	2.96
ML-O0520416	5/16" ML X 1/4" Male NPT	1.98
ML-O0620216	3/8" ML X 1/8" Male NPT	3.96
ML-O0620416	3/8" ML X 1/4" Male NPT	2.91
ML-O0620616	3/8" ML X 3/8" Male NPT	3.22
ML-O0620816	3/8" ML X 1/2" Male NPT	5.53
ML-O0820616	1/2" ML X 3/8" Male NPT	4.36
ML-O0820816	1/2" ML X 1/2" Male NPT	4.88



MUR-LOK FIXED NPTF ELBOWS

PART NUMBER	PRODUCT DESCRIPTION	PRICE \$
ML-P0420206	1/4" ML X 1/8" Female NPT	3.45
ML-P0420216	1/4" ML X 1/8" Male NPT	2.81
ML-P0420416	1/4" ML X 1/4" Male NPT	2.98
ML-P0420616	1/4" ML X 3/8" Male NPT	3.46
ML-P0520416	5/16" ML X 1/4" Male NPT	3.63
ML-P0620416	3/8" ML X 1/4" Male NPT	3.93
ML-P0620616	3/8" ML X 3/8" Male NPT	4.48



MUR-LOK UNION & REDUCING ELBOWS

PART NUMBER	PRODUCT DESCRIPTION	PRICE \$
ML-Q0420426	1/4" ML X 1/4" ML	2.97
ML-Q0520426	5/16" ML X 1/4" ML	3.69
ML-Q0520526	5/16" ML X 5/16" ML	3.34
ML-Q0620426	3/8" ML X 1/4" ML	4.83
ML-Q0620526	3/8" ML X 5/16" ML	4.81
ML-Q0620626	3/8" ML X 3/8" ML	4.36
ML-Q0820626	1/2" ML X 3/8" ML	5.68
ML-Q0820826	1/2" ML X 1/2" ML	5.18



MEDICAL SOLUTIONS INTERNATIONAL
 5646 MERRIAM DRIVE
 MERRIAM, KS 66203
www.medicalsolutionskc.com

800.326.5275
 913.438.9700
 FAX 913.438.9701

MUR-LOK REDUCERS

PART NUMBER	PRODUCT DESCRIPTION	PRICE \$
ML-S0420566	1/4" ML X 5/16" Stem	2.44
ML-S0420666	1/4" ML X 3/8" Stem	2.93
ML-S0520666	5/16" ML X 3/8" Stem	3.24
ML-S0620866	3/8" ML X 1/2" Stem	5.86



MUR-LOK NPTF STEM ADAPTERS

PART NUMBER	PRODUCT DESCRIPTION	PRICE \$
ML-S0460216	1/4" Stem X 1/8" Male NPT	1.98
ML-S0460416	1/4" Stem X 1/4" Male NPT	1.98
ML-S0660416	3/8" Stem X 1/4" Male NPT	2.48
ML-S0660616	3/8" Stem X 3/8" Male NPT	2.63
ML-S0860816	1/2" Stem X 1/2" Male NPT	2.85



MUR-LOK TUBE TO HOSE STEM ELBOWS

PART NUMBER	PRODUCT DESCRIPTION	PRICE \$
ML-S0460448	1/4" Stem X 1/4" BARB	2.96



MUR-LOK TUBE TO HOSE STEMS

PART NUMBER	PRODUCT DESCRIPTION	PRICE \$
ML-S0460446	1/4" Stem X 1/4" BARB	2.96
ML-S0660646	3/8" Stem X 3/8" BARB	3.18
ML-S0660846	3/8" Stem X 1/2" BARB	3.98
ML-S0860846	1/2" Stem X 1/2" BARB	3.68



MEDICAL SOLUTIONS INTERNATIONAL
 5646 MERRIAM DRIVE
 MERRIAM, KS 66203
www.medicalsolutionskc.com

800.326.5275
 913.438.9700
 FAX 913.438.9701

MUR-LOK FITTINGS-PLUG IN ELBOWS

PART NUMBER	PRODUCT DESCRIPTION	PRICE \$
ML-T0420466	1/4" ML X 1/4" Stem	3.93
ML-T0420666	1/4" ML X 3/8" Stem	4.63
ML-T0520566	5/16" ML X 5/16" Stem	4.46
ML-T0620666	3/8" ML X 3/8" Stem	5.32
ML-T0820866	1/2" ML X 1/2" Stem	5.94



MUR-LOK FITTINGS-UNION TEES

PART NUMBER	PRODUCT DESCRIPTION	PRICE \$
ML-V0420426	1/4" ML X 1/4" ML X 1/4" ML	4.68
ML-V0420526	1/4" ML X 1/4" ML X 5/16" ML	6.18
ML-V0520526	5/16" ML X 5/16" ML X 5/16" ML	4.82
ML-V0620426	3/8" ML X 3/8" ML X 1/4" ML	6.37
ML-V0620626	3/8" ML X 3/8" ML X 3/8" ML	5.79
ML-V0820426	1/2" ML X 1/2" ML X 1/4" ML	10.96
ML-V0820626	1/2" ML X 1/2" ML X 3/8" ML	7.24
ML-V0820826	1/2" ML X 1/2" ML X 1/2" ML	7.56
ML-V0820866	1/2" ML X 1/2" ML X 1/2" Stem	6.56



MUR-LOK FITTINGS-FEMALE CONNECTORS

PART NUMBER	PRODUCT DESCRIPTION	PRICE \$
ML-U0420206	1/4" ML X 1/8" Female NPTF	4.72
ML-U0420406	1/4" ML X 1/4" Female NPTF	6.56
ML-U0620406	3/8" ML X 1/4" Female NPTF	5.96



MEDICAL SOLUTIONS INTERNATIONAL
 5646 MERRIAM DRIVE
 MERRIAM, KS 66203
www.medicalsolutionskc.com

800.326.5275
 913.438.9700
 FAX 913.438.9701

NYLON GARDEN HOSE FITTINGS

PART NUMBER	PRODUCT DESCRIPTION	PRICE \$
GH-12-O	"O" RING for Garden Hose Fitting	2.49
GH-TA772	3/4" Male Garden Hose X 1/4" Male NPT	2.95
GH-TA774	3/4" Male Garden Hose X 1/2" Male NPT	2.95
GH-TA776	3/4" Male Garden Hose X 3/4" Male NPT	2.95
GH-TA792	3/4" Male Garden Hose X 1/4" Female NPT	2.95
GH-TA771	3/4" Male Garden Hose X 3/8" Barb	2.95
GH-TTA-772	3/4" Male Garden Hose X 3/4" Barb	2.95



NYLON WALL STATION DRAIN BARBS

PART NUMBER	PRODUCT DESCRIPTION	PRICE \$
W-ATE2	Wallstation Drain Barb 1" Male NPT X 3/4" Barb Elbow	2.74
W-ATA1	Wallstation Drain Barb 1" Male NPT X 3/4" Barb Straight	2.74



MEDICAL SOLUTIONS INTERNATIONAL
5646 MERRIAM DRIVE
MERRIAM, KS 66203
www.medicalsolutionskc.com

800.326.5275
913.438.9700
FAX 913.438.9701

TANKS		
PART NUMBER	PRODUCT DESCRIPTION	PRICE \$
T-ST120	120 Gallon stackable tank	QUOTE
T-ST220	220 Gallon stackable tank	QUOTE
T-ST225	225 Gallon stackable tank	QUOTE
T-ST330	330 Gallon stackable tank	QUOTE
T-10100	100 Gallon stackable tank	QUOTE
T-10150B	150 Gallon stackable tank on base	QUOTE
T-10160	160 Gallon storage tank	QUOTE
T-10165	165 Gallon storage tank	QUOTE
T-10200	200 Gallon storage tank	QUOTE
T-10200BP	200 Gallon storage tank w/pump on base	QUOTE
T-10250	250 Gallon storage tank	QUOTE
T-10300	300 Gallon storage tank	QUOTE
T-10500	500 Gallon storage tank	QUOTE
T-VC-200	Ventilation Cap for square stackable tank	QUOTE



ALL FORMS OF TANKS ARE AVAILABLE, WE ARE PLEASED TO QUOTE CUSTOM ORDERS.



ORDER FORM

DATE _____

PO# _____

BILL TO:

SHIP TO:

QUANTITY	ITEM#	DESCRIPTION	COST
_____	_____	_____	_____
_____	_____	_____	_____
_____	_____	_____	_____
_____	_____	_____	_____
_____	_____	_____	_____
_____	_____	_____	_____
_____	_____	_____	_____
_____	_____	_____	_____
_____	_____	_____	_____
_____	_____	_____	_____
_____	_____	_____	_____
_____	_____	_____	_____
_____	_____	_____	_____
_____	_____	_____	_____
_____	_____	_____	_____
_____	_____	_____	_____
_____	_____	_____	_____
_____	_____	_____	_____
_____	_____	_____	_____
_____	_____	_____	_____
_____	_____	_____	_____

EMAIL: sales@medicalsolutionskc.com
FAX: 913-438-9701

MEDICAL SOLUTIONS INTERNATIONAL 5646 MERRIAM DRIVE, MERRIAM, KANSAS 66203
800-326-5275, 913-438-9700, FAX 913-438-9701



Medical Solutions

I N T E R N A T I O N A L

5646 Merriam Drive Merriam, Kansas 66203
913-438-9700 Fax 913-438-9701 800-326-5275
www.medicalsolutionskc.com